

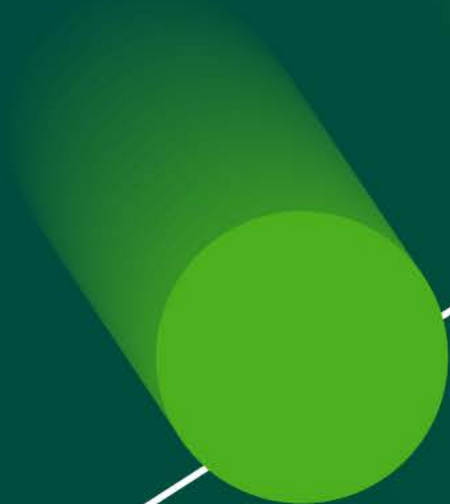

ITTF COUNCIL MEETING

WORKING DOCUMENTS

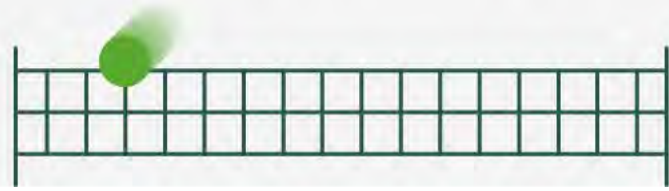



2026 INTERNATIONAL TABLE TENNIS FEDERATION COUNCIL MEETING

The 2026 ITTF Council Meeting of the International Table Tennis Federation will be held in London, UK, in a hybrid format on Saturday, 2nd May 2026, starting at 09h00 GMT+1 (Greenwich Mean Time +1).

AGENDA

1. President's Welcome and Opening Address
2. Roll Call
3. Confirmation of the Agenda
4. Confirmation of the Minutes of the ITTF Council Meeting held on 26th May 2025 in Doha, Qatar
5. Annual reports of the Athletes Commission and Commissioners
 - 5.1 Athletes' Commission
 - 5.2 Technical Commissioner
 - 5.3 Gender and Diversity Commissioner
 - 5.4 Youth Commissioner
6. Appointment of new Members to the Audit and Finance Committee
7. Appointment of Committee Chairs
8. Size of Committees 2027-2029
9. Propositions and Resolutions
 - 9.1 General Propositions and Resolutions
 - 9.2 Competition Playing Systems
10. Competition Updates
 - 10.1 World Title Events
 - 10.2 World Youth Events
 - 10.3 World Masters Events
 - 10.4 Para Table Tennis
 - 10.5 World Cups
 - 10.6 Dakar 2026
11. Election of the ITTF World Masters Championships 2027 and 2028 hosts
12. Election of the ITTF World Youth Championships 2027 and 2028 hosts
13. Next ITTF Council Meeting
14. Any Other Business
15. Adjournment

1. Introduction

Throughout 2025, the Athletes' Commission (AC) continued its work to represent the voice of players within the ITTF ecosystem and to strengthen the dialogue between athletes, the International Table Tennis Federation (ITTF), and World Table Tennis (WTT).

The Commission remained focused on ensuring that athlete perspectives are reflected in discussions related to competition structures, tournament scheduling, officiating, equipment regulations, and the overall professional environment of the sport.

During the year, the AC engaged with athletes from different regions and levels of competition, gathering feedback and sharing insights with relevant ITTF stakeholders. The Commission also continued its efforts to strengthen athlete representation within the governance framework of table tennis, promoting open communication and constructive collaboration across the sport.

2. Key Discussions and Updates

2.1 Online Meetings and Athlete Consultations

During 2025, the Athletes' Commission held a number of online meetings and consultations with athletes and stakeholders to discuss matters affecting the global player community.

Key topics raised by athletes included:

- **Competition Calendar Planning:** The importance of early announcement of the international calendar to allow athletes to plan their training and travel schedules more effectively.
- **World Ranking System:** Continued dialogue on ranking point distribution and how it influences participation decisions.
- **Player Welfare:** Athletes highlighted the increasing demands of the international competition schedule and the need to balance performance, recovery, and travel requirements.

The feedback gathered during these discussions was communicated to ITTF and WTT leadership as part of ongoing efforts to improve the athlete experience.

2.2 Feedback on Major Events

Athletes expressed generally positive feedback regarding several major competitions held during the year. Many players highlighted improvements in event organisation, competition venues, and athlete services.

The continued development of events under WTT has contributed to raising the professional standard of international competitions and enhancing the global visibility of the sport. These improvements have been positively acknowledged by athletes across different regions.

2.3 Collaboration with ITTF Committees

During 2025, the Athletes' Commission also engaged in discussions with other ITTF bodies, including the ITTF Equipment Committee and the ITTF Umpires and Referees Committee (URC).

Exchanges with the Equipment Committee focused on equipment regulations and their impact on athletes, particularly with regard to consistency, fairness, and the practical implications of rule implementation during competitions.

Dialogue with the Umpires and Referees Committee addressed topics related to officiating standards, rule interpretations, and communication between athletes and officials. These discussions were constructive and aimed at strengthening mutual understanding while ensuring the integrity and fairness of competition.

The Athletes' Commission values this collaboration and believes that continued engagement between committees contributes positively to the development of the sport.

3. Positive Developments for Athletes

3.1 Continued Improvements in Event Organisation

WTT events continued to deliver high standards in competition organisation, athlete services, and broadcast presentation. These developments contribute significantly to the professionalisation of table tennis and create a more supportive environment for athletes.

3.2 Constructive Dialogue with Stakeholders

The Athletes' Commission maintained regular communication with ITTF and WTT representatives throughout the year. This dialogue has helped ensure that athlete perspectives are considered when reviewing regulations, competition formats, and operational matters affecting players.

3.3 Increased Athlete Engagement

Athletes from different regions have continued to actively share feedback and perspectives with the Commission. This engagement helps ensure that the Commission reflects a broad and diverse representation of the global athlete community.

4. Requests and Concerns from Athletes

4.1 Cost of Participation

Athletes continue to highlight the financial challenges associated with competing on the international circuit. Travel, accommodation, and hospitality requirements remain significant expenses, particularly for athletes without strong federation or sponsor support.

The Commission continues to advocate for measures that help reduce these financial burdens and support sustainable athlete participation.

4.2 Competition Calendar and Scheduling

Athletes have emphasised the importance of announcing the international competition calendar well in advance to allow proper planning of training cycles and participation schedules.

Avoiding overlaps between major events and ensuring sufficient recovery time between tournaments remain key considerations for athlete welfare.

4.3 Communication within the Athlete Community

The Athletes' Commission continues to explore ways to improve communication among athletes worldwide and to ensure that players are well informed about regulatory updates and developments within the sport.

Strengthening communication channels will help foster greater collaboration and engagement within the global table tennis community.

The Athletes' Commission remains committed to working collaboratively with ITTF, WTT, and all stakeholders to ensure that athletes remain at the centre of the sport's continued development.

Sharath Kamal ACHANTA and LIU Shiwen

Co-Chairs of the Athletes' Commission

The mandate of the Technical Commissioner includes:

- Consult with the Competition Department and advise the ITTF Council on the organisation of the Olympic Games, and World Title competitions, and make recommendations on the system of play;
- Assist the Competition Department and referee team with the World Championships draws;
- Advise on the playing schedule for the Olympic Games and World Title competitions, as necessary;
- Serve as a member of the World Ranking Working Group;
- Serve as a member of the other Working Groups as required;
- Provide advice on eligibility matters;
- Function as the Chair of the Jury at the World Championships;
- Provide technical assistance for Multi-Sport Games and Continental Championships;
- Work closely with the Competition Department to achieve the above objectives; and
- Provide technical expertise and guidance to the Rules, Umpires and Referees Committees, Para Table Tennis, and professional staff.

These responsibilities are managed in close cooperation with the Competition Department.

In 2025 my key role was to assist the ITTF and the Competition Department with the playing format, schedules, and general inquiries relating to technical rules for major events. These included the qualification, playing system and schedule for the 2026 World Championships, 2028 Olympic Games Qualification, 2028 Paralympic Games Qualification, World Cup, Mixed Team World Cup, World Para Championships and World Youth Championships.

I am a member of the World Ranking Group looking at various items and have also provided technical expertise and assistance as required to other Working Groups and Committees, mainly to the URC, and the ITTF staff, whenever requested.

I am also available to consult with the continental representatives on technical issues related to continental events to align them more closely with the ITTF and WTT events.

Graeme IRELAND

ITTF Technical Commissioner

Note: *This report is based in part on the work of Ms Hajera Kajee in her capacity as ITTF Gender and Diversity Commissioner up to 27 May 2025, the end of her term of service. It is complemented by the ITTF to reflect relevant activities and developments in the area of gender and diversity from 28 May 2025 to 31 December 2025.*

The year 2025 started off with a lot of excitement and enthusiasm to implement the Goals of the GEDI Action plan. Firstly, I want to thank the President, Ms Petra Sörling and the ITTF Executive Board for my term of service as the ITTF Gender Commissioner, which ended on the 27th May 2025. The ITTF has elected the Gender Equality, Diversity and Inclusion Committee to oversee and implement the GEDI Strategic Goals.

Strategic Goal 1. To promote Women's Leadership and Gender equality in Governance models

Continued collaboration with ITTF Human Resources to embed GEDI education into staff induction and ongoing training, building on work initiated in 2024. Participants were sponsored for the ASOIF Women Lead Sports programme, sustaining the ITTF's investment in female leadership pathways across the membership. Continued engagement with the IOC on GEDI implementation, with a renewed focus on the persistent underrepresentation of women among elected and appointed officials.

Strategic Goal 2: Undertake efforts to prevent and respond to violence against women and girls in and through sports

The Sustainability Pledge prerequisite in the ITTF Event Manual continued to be applied to all bidding processes, including for the ITTF World Table Tennis Championships Finals 2026 in London, ensuring that host organisations commit to safeguarding, equality, and social inclusion. The ITTF Integrity Unit maintained its monitoring and categorisation of reported cases and continued its collaboration with the IOC Safe Sport Unit to advance a comprehensive safe sport approach across the ITTF Group, including the ongoing development of regulatory, policy, and cultural change backed by education.

Strategic Goal 3: Undertake efforts to close the gap in investment in women's sport and promote equal economic opportunities for women and girls

The "My Gender. My Strength." Development Project continued in 2025, building on the record interest seen in 2024, when 50 applications were received and 20 female coaches from all five continents were supported. The 35% minimum female representation requirement across all Participation Programme activities was maintained, following 2024's achievement of 42% female participation across 10,673 programme participants. The proportion of women qualifying as ITTF coaches rose to 41% in 2024 (up from 30% in 2022), and as match officials to 34% (up from 31%), with continued progress targeted. For the 21st consecutive season, the ITTF ensured equal prize money and participation across all its events. Preparations continued for the historic inclusion of the Mixed Team event at the Los Angeles 2028 Olympic Games, a tangible expression of table tennis's leadership on gender parity in competition formats.

Strategic Goal 4: Undertake efforts to promote women's equal participation and bias-free representation in sports media, including communications to eliminate harmful gender stereotypes and to promote positive role models

On 8 March, a social media campaign was launched for International Women's Day 2025, highlighting the achievements of female and Para athletes across all continents. The ITTF continued to increase the visibility of female and Para role models on ITTF.com and across social media channels, ensuring the use of inclusive language in all communications. The ITTF Foundation's Diversity and Inclusion Handbooks (Phases 1 and 2) continued to be promoted and distributed across Member Associations. The dedicated GEDI section on the ITTF website was further developed to provide accessible and up-to-date information on all GEDI initiatives.

Strategic Goal 5: Undertake efforts to support equal opportunities for girls in sports, physical activity, and physical education

The ITTF Foundation continued to deliver Safe Spaces for Girls workshops in collaboration with ITTF Development, equipping coaches from across the membership with practical knowledge to create safe and empowering environments for girls. Projects funded through the Dream Building Fund's 2023 call, which attracted a record 177 applications from 64 countries and territories with a focus on diversity and inclusion, moved into active implementation, delivering tangible community impact. GEDI sessions were delivered at key ITTF gatherings during 2025, reinforcing the embedding of diversity and inclusion across the sport's ecosystem.

Strategic Goal 6: Agree to monitor and publicly report on progress on an annual basis

The GEDI Action Plan Review and Progress Report 2023-2025, published in January 2026, represents the most comprehensive and data-driven review of GEDI implementation to date. For the first time, systematic data was collected and compared across governance, staffing, and participation, revealing that 38% of indicators have been achieved and 49% are in progress. Progress reports were shared with UN Women, the International Working Group on Women and Sport, and the International Olympic Committee, in line with the ITTF's commitments to transparency and accountability. Monitoring of gender-balanced representation continued across all social media content and published articles.

Cross-Cutting Achievements

The UN Women partnership continued to deepen in 2025, with financial support confirmed for GEDI initiatives in alignment with the UN Women Sports for Generation Equality Framework, which the ITTF endorsed in March 2024. The ITTF's recognition in the 2024 ASOIF Governance Task Force Review, placing us in Group A2 among 32 International Federations, further affirmed our standing as a gender-sensitive and inclusive organisation. The publication of the GEDI Action Plan Review and Progress Report 2023-2025 stands as a landmark deliverable: the first time the ITTF has systematically measured and publicly reported its performance against all six strategic goals.

Conclusion

I would like to express my appreciation to the ITTF staff for their support during my tenure as the ITTF GEDI Commissioner.

Hajera KAJEE

ITTF Gender and Diversity Commissioner

As we close the first cycle of the GEDI Action Plan and gather here in London for the World Table Tennis Championships and the ITTF Centenary, the foundations we have built together over the past three years give us cause for both pride and resolve. Much has been achieved; much remains to be done, particularly in increasing the representation of women in elected and

appointed leadership roles. Inclusion is a continuous journey, and the ITTF remains grateful for the collective commitment that drives it forward.

International Table Tennis Federation (ITTF)

Dear ITTF Council Members,

I look forward to meeting you all in London at the ITTF Council meeting. Here is my report:

WTT Youth Series

In 2025, the WTT Youth Series featured a record number of 63 events, demonstrating its broad acceptance. This enabled WTT to have 6 YOUTH Star Contenders, 54 Contenders on all continents, and, as the highlight, 3 Youth Smashes in the Youth Series Calendar:

	Africa	Asia	Europe	Oceania	Americas
Youth Contender	3 (in 2 Associations)	14 (in 13 Associations)	22 (in 21 Associations)	1 (Australia)	14 (in 8 Associations)
Youth Star Contender	1	2	3		
Youth Smash		2 (Singapore, China)	1 (Sweden)		

- Corresponding to the increased number of events, the member Associations sent in a total 4797 players to the events in 2025 (over 600 more than in 2024).
- 11 events gathered more than 250 players, and the average number of Member Associations taking part in the events was higher than 21. Players from 50 Member Associations from all 5 continents won at least one singles title.
- 2025 around 880 players were U11, born after 1. January 2014.
- More than 5000 players are listed in the ITTF Table Tennis Youth Ranking (highest number ever).

The application process for the 2026 WTT Youth Series in Summer 2025 showed great interest again. The Youth Series Calendar for 2026 was published in the Summer of 2025 and includes more than 70 events

Thank you very much to Tiago Viegas, WTT Head of Feeder and Youth Series, and his staff for the incredible work to put the puzzle of dates for the events together, and for the very good work towards the host associations to get the events done.

ITTF World Youth Championships (WYC)

The 2025 WYC took place in the city of Cluj-Napoca in Romania from 23rd to 30th November 2025. Many thanks to the Romanian Table Tennis Federation, which did an incredible job with their organization, setting the perfect stage for the young players. The Arena in Cluj-Napoca proved an outstanding host venue, with passionate crowds supporting competitors throughout the week.

The WYC showcased the exceptional depth of talent in global table tennis, with athletes from across the world demonstrating the skill, determination, and sportsmanship that define the sport. This time, 39 Member Associations, which is a record, were represented by their promising athletes.

Players from 15 Member Associations won medals in the Championships, 6 of them brought gold medals home (CHN, JPN, GER, THA, TPE WAL). The most successful Associations were China with 6 titles, followed by Japan with 3 and Chinese Taipei, China and Germany with 2 titles.

Finally, I thank everyone involved and engaged in the WTT Youth Event Series program and WYC – a special thank you goes to Tiago Viegas as the WTT Head of Feeder and Youth Series for his great work. Thank you to all involved in the work for youth table tennis for your cooperation and good work.

Heike AHLERT

ITTF Youth Commissioner

Propositions & Resolutions to the 2026 ITTF Council

Proposition IC-01

(Simple majority required)

Proposed by the ITTF Umpires and Referee Committee

To remove 3.4.1.2.1 and 3.4.1.2.2

~~3.4.1.2.1 — When a point has been scored, he or she may raise his or her arm nearer to the player or pair who won the point so that the upper arm is horizontal and the forearm is vertical with the closed hand upward.~~

~~3.4.1.2.2 — When for any reason the rally is a let, he or she may raise his or her hand above his or her head to show that the rally has ended.~~

Rationale:

3.4.1.2 defines that hand signals may be used:

"3.4.1.2 In addition to calling the score the umpire may use hand signals to indicate his or her decision"

Detailed instructions about the procedure and the use of hand signals are included in the Handbook for Match Officials. Changes especially taking into account the use of electronic systems/touchpad can easily be implemented in the Handbook for Match officials. There is no need to add detailed instructions in the Statutes.

Propositions & Resolutions to the 2026 ITTF Council

Proposition IC-02

(Simple majority required)

Proposed by the Member Association of China (CHN)

To add:

3.2.7.2 During the events where Table Tennis Review (TTR) system is used, the system's cameras must be positioned in the most suitable positions to provide the best possible video angles for officiating decisions during matches. This priority should supersede any considerations related to broadcasting or media needs.

Rationale:

Ensuring that TTR cameras are installed in the most optimal locations provides the most accurate possible replay videos for officiating decisions.

Propositions & Resolutions to the 2026 ITTF Council

Proposition IC-03

(Simple majority required)

Proposed by the Member Association of Switzerland (SUI)

To add:

3.1.2.8.1 The International Table Tennis Federation (ITTF) shall ensure long-term planning stability for its Member Associations by publishing the dates of major international and national competitions with sufficient advance notice.

3.1.2.8.2 The following events shall be considered major competitions for the purpose of this Article:

a) ITTF World Championships (individual and team);

b) Continental Championships organised under the authority of the ITTF or its Continental Federations;

c) National Championships of Member Associations, where such dates are subject to coordination or constraints imposed by the ITTF international calendar.

3.1.2.8.3 The ITTF shall publish the official dates of the competitions listed above no later than three (3) calendar years prior to the year in which the event takes place.

3.1.2.8.4 Once published, these dates shall be regarded as binding elements of the international calendar. Changes may only be made in exceptional circumstances, such as force majeure or governance decisions, and must be duly justified and communicated to Member Associations without delay.

3.1.2.8.5 The ITTF Executive Board shall be responsible for the implementation and supervision of this Article and shall ensure that the international calendar supports the organisational, logistical, and infrastructural constraints of Member Associations.

Rationale:

Sports halls/venues are shared with other sports, which often operate with planning horizons of three to five years. In order to respect athletes with international commitments and to allow national associations to establish their own competition calendars, these dates—defined at the top of the pyramid—must be known sufficiently in advance. This enables all bodies below the ITTF level to publish their calendars with adequate lead time.

These measures, which would be cost-neutral for the ITTF, would allow continental, national, and regional associations to plan more effectively, saving several thousands of dollars.

Propositions & Resolutions to the 2026 ITTF Council

Proposition IC-04

(Simple majority required)

Proposed by the ITTF Equipment Committee

To modify the MANUAL M1 - TABLES:

2.6 Advertisements/Markings on table

[...]

- Each side of the table shall carry once the ITTF logo indicating that the table is ITTF-approved. The logo shall be visible in an area of at least 25 9 sqcm and not more than 50 sqcm that may be located on the frame of the tabletop or on the undercarriage.

[...]

Rationale:

The frame sizes of the tables getting smaller to fit wheelchair regulation. Within this regulation, manufacturer realized they can produce quality tables with less frame material for every ITTF approved table. The new size guarantees a general procedure for ITTF Logo sizes.

Propositions & Resolutions to the 2026 ITTF Council

Proposition IC-05

(Simple majority required)

Proposed by the ITTF Equipment Committee

To modify the MANUAL M2 – NET ASSEMBLIES:

2.10. TENSION & HEIGHT ADJUSTMENT

a) [...]

CHECK OF TENSION AND HEIGHT AT THE TABLE

The tension of the net cord may be checked in the middle of the table either by fingers, or much better by a 100g **net tension gauge** ~~heavy tension gauge~~. The 142 mm to 143 mm high part of the gauge should hang on the net; the tension is good, if the bottom of the gauge comes next to the tabletop surface, but without or just touching it. Otherwise, the devices to adjust the net tension must be operated.

The height of the net shall be checked about 30 cm from the upright posts, but not in the middle of the table: the legal height must be adjusted accurately. The height should be adjusted with the **standard net gauge** ~~normal light net gauge~~ that does not depress the net: the bottom of the freely and vertically hanging gauge should just touch the tabletop. Otherwise, the devices to adjust the net height have to be operated until the 152.5 mm are reached

[...]

Rationale:

General change for the naming of the net gauges, that is why it should be changed in the M2 – Net Assembly as well.

Propositions & Resolutions to the 2026 ITTF Council

Proposition IC-06

(Simple majority required)

Proposed by the ITTF Equipment Committee

To modify MANUAL M5 – NET GAUGE

1.1. INTRODUCTION

~~At present, net gauges are not applicable equipment for approval by ITTF. Nevertheless,~~ net gauges have a very important role to keep the matches fair such that:

- (i) the result of a rally should not be influenced by the net condition or
- (ii) a net gauge can indicate illegality of players' racket.

~~Net gauges can also be used for the detection of glossy surfaces of rubbers.~~

~~Therefore, the ITTF intend to regulate the specifications or requirements of the net gauge as "Technical Guidelines".~~ Umpires should use only a net gauge conforming to the requirements described in this ~~"Technical Guidelines" document~~ **Manual**. The responsible person should check the capability of umpires' net gauges, not only for using as a net gauge, but also when it will be used as a tool for Racket Control, before starting the tournament.

How to check or adjust the tension and the height of the net by using net gauge, **is** ~~These are~~ concretely described in ~~Technical Leaflet T2~~ **Manual M2** - The Net Assembly. It is strongly recommended to first adjust for tension and then for height.

How to check the thickness of rubbers with net gauge, **it** is described in detail in ~~Technical Leaflet T9~~ **Manual M9** - Racket Control.

1.2. ITTF LOGO AND TRADEMARK

The ITTF approved net gauges are identified by their brand names and by the ITTF logo, or other ITTF indications. They must wear the ITTF logo wherever they are sold or used! All names must be in Roman or Latin letters, and additionally they may be in another language. The name may contain numbers.

The ITTF will make its best effort to ensure that the trademark or brand name does not infringe on the already existing net gauge brands. The ITTF is not responsible for any illegal use of registered trademarks. Verifying the correct and legal use of trademarks is not part of the ITTF approval procedure.

1.3. CONTACT

ITTF Equipment Office

Kaesenstrasse 17

50677 Cologne - GERMANY

Tel: +49 221 42343366

E-mail: equipment@ittf.com

Propositions & Resolutions to the 2026 ITTF Council

2. STANDARDS TO ACHIEVE

Two types of net gauges are wholly used by umpires:

1. ~~Light net gauges~~ **Standard net gauge**: They are to be used for the adjustment of the height of the net, at about 30 cm from the net posts. **Specifications and dimensions are given in figure 1.**
2. ~~Heavy net gauges~~ **Net tension gauge**: They are to be used exclusively for the adjustment of the net tension, in the middle of the net. This cannot be used for adjusting the net height. **Specifications and dimensions are given in figure 2.**

- ~~— correct, safe or quick determinations of the tension of the net: 3~~
- ~~— reliable checks of the thickness of racket coverings: 1,2,5,6~~
- ~~— correct checks of the flatness of racket sides: 2,4~~

Additionally, to the above functions of the net gauge, a ~~light net gauge~~ **standard net gauge** may often be used to check the extensions, flatness and thickness of the rubbers on a player's racket as well as the height of the cushions of the wheelchairs.

2.1. PRODUCT AND BRAND

The name of a product is always composed by the brand name and the net gauge type name. Both together define the product in a unique way so that confusions will be avoided and consumers are correctly informed.

If ~~the responsible person~~ **ITTF** confirms that a net gauge satisfies all the requirements **within this manual shown in table 1, he/she gives** the approval **will be given** to the ~~supplier~~ **brand** to use the ITTF logo ~~and the manufacturing date~~ on the net gauges.

The approval is only valid for the specific manufacturing series and any changes for future manufacturing series should first be approved by the ITTF.

2.2. MANUFACTURING

ITTF recommends manufacturers and brand to strictly apply the technical and other legal regulations of the user's home countries. The ITTF cannot be held responsible in case of non-observance of any additional or different national request; the ITTF approval sets up ITTF standards guaranteeing a safe and reliable table tennis at top-level events.

New materials, new manufacturing processes or a change of the producer, what could result in different properties, need to be announced to ITTF and require new testing.

2.3. SPECIFICATIONS

All net gauges may have a height of about 180 mm. Their width shall be less than 48 mm (**net tension gauge** (heavy gauges)) and less than 42 mm (**standard net gauge** (light gauges)) but slimmer is better. Their thickness shall be 2.0 mm so that they can be used for determining the extension of the racket covering up to or beyond the edges of the blade ~~as recommended in HMO 7.1.1~~. As net gauges can also be used for the detection of glossy surfaces at an angle of about 45°, their background may be dark and letters or logos may be white.

Figures 1 & 2 draw basic shapes for net gauges used at ITTF tournaments. Other features may be added but may not change a basic requirement as described in table 1 **and 2** and in the text.

Propositions & Resolutions to the 2026 ITTF Council

The design of a net gauge shall allow it to hang vertically on a cord. If it does not, the centre of gravity of its plane is located outside its medium vertical axis, which may lead to incorrect measurements because the lower part of the gauge will touch the net. For the same reason, the central split may not be narrower than 7 mm.

On one side the net gauge shall have an incision of 4.0 mm with a tolerance of +/- 0.05mm, and on the other side it may have an incision of 2.0 mm with a tolerance of +/- 0.05mm. The angles of the projecting part at the top of the incisions must be 90° exactly and rounding on the outside or inside corners is strictly prohibited. The height of the lateral incisions shall not be less than 152.5 mm, so that both long edges can be used for flatness checks.

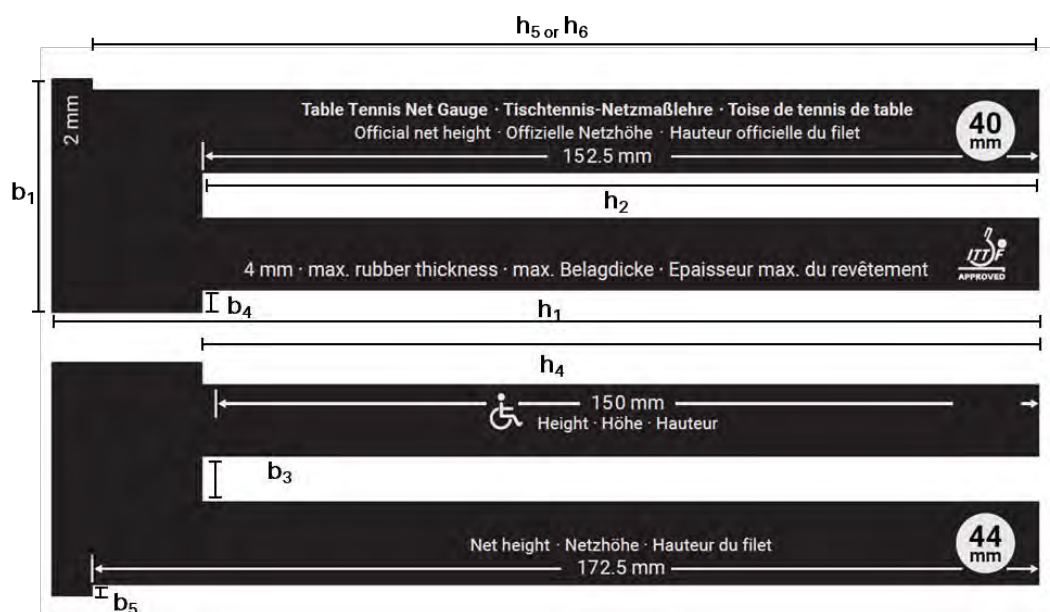

Figure 1: Standard Net Gauge (Light Gauge)

Propositions & Resolutions to the 2026 ITTF Council

The market presently provides **net tension gauges** (heavy gauges) with a central split, open up to 15 mm, for the height.

As long as the **net tension gauges** (heavy gauge) can hang vertically and safely on the net for the height of 142.5 mm, its central split is acceptable for the tension adjustment (but should not be used for the height adjustment). Lateral incisions are not made for tension adjustment; height adjustments are possible but they are fussy and questionable. Therefore, lateral incisions may not be used for adjusting the tension or the height of the nets. Lateral edges must be straight because gauges are used for the check of thickness and flatness of the rackets.

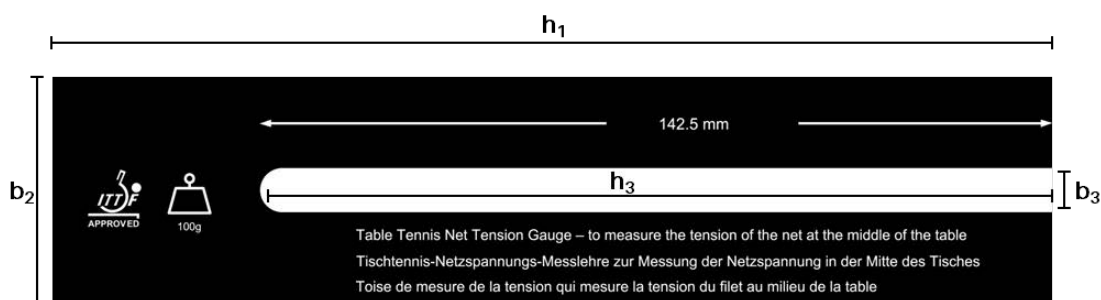

Figure 2: Net Tension Gauge (Heavy Gauge)

Propositions & Resolutions to the 2026 ITTF Council

2.3.1. DIMENSIONS - STANDARD NET GAUGE

	Code	Description	Dimension [mm]	Fig.
Standard Specifications	-	background colour/lettering colour	dark/white	1/2
	h_1	height	~180	1/2
	b_1	width	≤ 42	1
	t	thickness	2.0 ± 0.1	-
	-	weight (in g)	< 15	-
	-	Vertical hanging on the net cord	balanced	-
	h_2	height of central split	152.5	1
	b_3	width of central split	7 - 12	1/2
	-	roundness of central split top	straight	-
Lateral incisions (for racket covering thicknesses)	b_4	depth of lateral incision (for racket covering with sponge)	4.0 ± 0.05	1
	h_4	height of lateral incision (for racket covering with sponge)	152.5	1
	-	Sides of lateral incision top (at height h_4)	straight	-
	-	Inner Corner on top of the lateral incision (at height h_4)	90° sharply	-
	-	Outer Corner on top of the lateral incision (at height h_4)	90° sharply	-
	b_5	depth of lateral incision (for racket covering without sponge)	2.0 ± 0.05	1
	h_5	height of lateral incision (for racket covering without sponge)	152.5	1
	h_6	height of lateral incision (for racket covering without sponge)	172.5	1
	-	Sides of lateral incision top (at height h_5 or h_6)	straight	-
	-	Inner Corner on top of the lateral incision (at height h_5 or h_6)	90° sharply	-
	-	Outer Corner on top of the lateral incision (at height h_5 or h_6)	90° sharply	-

Table 1: Dimension of the standard net gauge [mm]

2.3.2. DIMENSIONS - NET TENSION GAUGE

Propositions & Resolutions to the 2026 ITTF Council

	Code	Description	Dimension [mm]	Fig.
Standard Specifications	-	background colour/lettering colour	dark/white	1/2
	h_1	height	~180	1/2
	b_2	width	≤ 48	2
	t	thickness	2.0 ± 0.1	-
	-	weight (in g)	$100 \pm 0,5 \pm$ 1	2
	-	Vertical hanging on the net cord	balanced	-
	h_3	height of central split	142.5	2
	b_3	width of central split	7 - 12	1/2
	-	roundness of central split top	round	-
Lateral incisions (for racket covering thicknesses) only optional	b_4	depth of lateral incision (for racket covering with sponge)	4.0 ± 0.05	1
	h_4	height of lateral incision (for racket covering with sponge)	152.5	1
	-	Sides of lateral incision top (at height h_4)	straight	-
	-	Inner Corner on top of the lateral incision (at height h_4)	90° sharply	-
	-	Outer Corner on top of the lateral incision (at height h_4)	90° sharply	-
	b_5	depth of lateral incision (for racket covering without sponge)	2.0 ± 0.05	1
	h_5	height of lateral incision (for racket covering without sponge)	152.5	1
	h_6	height of lateral incision (for racket covering without sponge)	172.5	1
	-	Sides of lateral incision top (at height h_5 or h_6)	straight	-
	-	Inner Corner on top of the lateral incision (at height h_5 or h_6)	90° sharply	-
	-	Outer Corner on top of the lateral incision (at height h_5 or h_6)	90° sharply	-

Table 2: Dimension of the net tension gauge [mm]

Propositions & Resolutions to the 2026 ITTF Council

2.4. ADVERTISEMENTS/MARKINGS

There are no rules for advertisements/markings on the net gauges, other than

- The ITTF logo shall only be used for net gauges that have been approved by the ITTF.
- The brand name or brand logo must be visible.
- The model name is indicated (Standard net gauge or Net tension gauge)
- All relevant dimensions shall be properly indicated on the gauge:
 - o Lateral incisions (4.0 mm or 2.0 mm)
 - o Indication for official net height with 40 mm ball (152.5 mm)
 - o Indication for net height with 44 mm ball (172.5 mm) (optional)
 - o Along one of its edges the net gauge shall have a ruler of ~~15cm~~ 150 mm scaled in mm so that it may serve for measurements as the height of the cushions of wheelchairs (see figure 1). (optional)
 - o 100 g weight marking or symbol (only for net tension gauges).



Figure 3: ITTF logo

For more information, please refer to the ITTF Branding Guidelines. Both, the guidelines and the versions of the ITTF logo, can be requested from ITTF Equipment Department.

3. TESTING-PROTOCOL

3.1. TESTING PROCEDURE

PREPARATION FOR TESTING LABS

The brand or manufacturer has to send the net gauges to the testing lab, mentioned under 3.3.

SEQUENCE OF TESTING

1. Net gauge specifications
 - a. Eyesight inspection
 - b. Tactile inspection
 - c. Markings/advertisements
 - d. Net gauge dimensions
2. Report (in ITTF Approval Forms)

After the testing and receiving the results, the net gauges will be kept in ITTFs archive.

PREPARATION FOR ITTF EQUIPMENT OFFICE

The brand or manufacturer has to send the following samples to the Equipment Office:

- Standard net gauge (if applied for) with original packaging (if available)
- Net tension gauge (if applied for) with original packaging (if available)

3.1.1.EYE-SIGHT AND TACTILE INSPECTION

Propositions & Resolutions to the 2026 ITTF Council

Gauges showing any of the following, **but not limited**, defects shall not be used, ~~because they do not allow:~~

- Edges not straight (1) and (4)
- Inside corner rounded (2)
- Top of the tension split straight (3)
- Rounded outside corner at the top of a lateral incision (5)
- ~~- Lateral incision depths different to 4.0 or 2.0 mm (6)~~

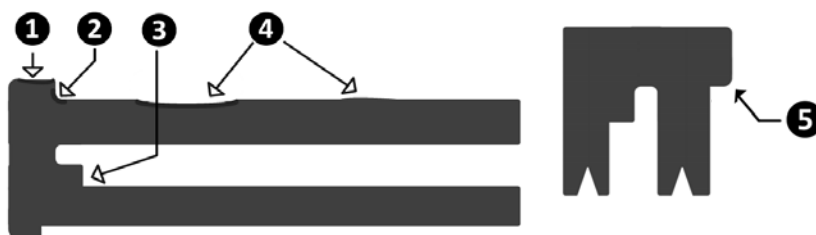

Figure 4: Prohibited defects of net gauges

3.1.2. DIMENSIONS

A vernier caliper, a large size, 200 mm, is recommended for checking each dimension of a net gauge. You can buy it at any tools shop. You don't need to select a high precision one. All dimensions will be measured with a digital caliper gauge (KYNUP; 300 mm; accuracy to ± 0.0015 inches/0.03 mm)

3.1.3. WEIGHT

The weight of the net gauges will be measured with a high precision scale (KERN PNJ 600-3M).

3.2. SELF-TESTING

There are two testing to check the 2.0 mm or 4.0 mm lateral incisions on the standard net gauge and net tension gauge, when using a new net gauge, for example during an event:

1. Easy method for checking the net gauge by using **Using** metal pins. The accuracy of the diameter of the metal pins should be 3.95 mm ~ 4.00mm.

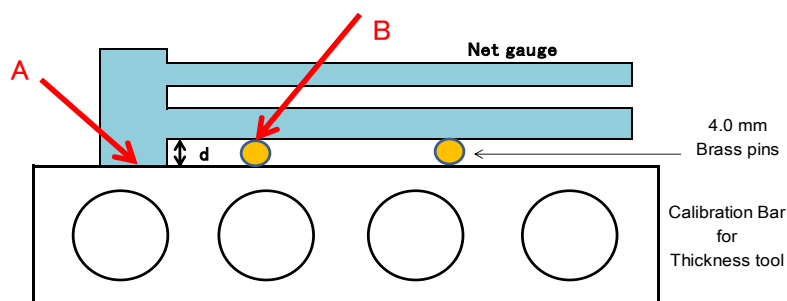

Figure 5: Easy Method for checking the net gauge, by using metal pins

- 1) d of net gauge ≤ 4.0 mm \rightarrow any gap will be found at A (tolerance ≤ 0.1 mm)
- 2) d of net gauge ≥ 4.0 mm \rightarrow any gap will be found at B (no tolerance)

Propositions & Resolutions to the 2026 ITTF Council

2. ~~The easy method for checking the net gauge is by using~~ Using the digital thickness device for racket coverings. This method is suitable to check the net tension gauge (heavy net gauge), but not the standard net gauge (light net gauge) because of bending under the weight of the digital device.

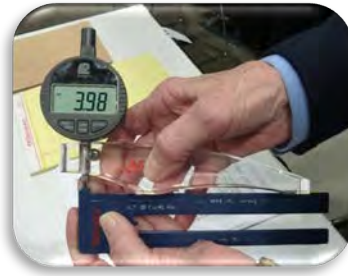

Figure 6: Easy method for checking the net gauge by using the digital thickness device

3.3. TESTING LAB



Kaesenstrasse 17

50667 Köln

GERMANY

3.4. SERVICES

Any brand bearing an approval of one or more products is invited to seek further explanations to the results of testing, to matters of calculation, statistical evaluation or – as far as confidentiality is not affected – general benchmarks from the ITTF net gauges testing results database. Such service is included in the approval fee.

6. ANNEX

6.1. TERMS OF REFERENCE

The Laws of Table Tennis relating to the net gauges are as follows:

- 2.2.3 The top of the net, along its whole length, shall be 152.5mm above the playing surface.
- 2.4.1 The racket may be of any size, shape or weight but the blade shall be flat and rigid.
- 2.4.3 A side of the blade used for striking the ball shall be covered with either ordinary pimples rubber, with pimples outwards having a total thickness including adhesive of less than 2.05mm, or sandwich rubber, with pimples inwards or outwards, having a total thickness including adhesive of less than 4.05mm, subject to any margin of tolerance specified in the relevant technical equipment document.
- 2.4.4 The blade, any layer within the blade and any layer of covering material or adhesive on a side used for striking the ball shall be continuous and of even thickness. Material suitable to shape a handle for holding the racket may be added on.

Propositions & Resolutions to the 2026 ITTF Council

The Regulations in Manual M2 – Net Assembly state as follows:

2.10 The tension of the net cord may be checked in the middle of the table either by using fingers or, preferably, by a 100g **net tension gauge** ~~heavy tension gauge~~. The 142.5mm high part of the gauge should hang on the net; the tension is correct if the bottom of the gauge comes next to the table-top surface without touching it. Otherwise, the devices to adjust the net tension must be operated.

The height of the net shall be checked about 30cm from the upright posts: it shall reach the correct height. The height should preferably be adjusted with the **standard net gauge** ~~normal light net gauge~~ that does not depress the net: the bottom of the freely and vertically hanging gauge should just touch the table-top. Otherwise, the devices to adjust the net height have to be operated until the 152.5mm are reached everywhere.

~~The Regulations in the Directives for PTT Events (for Wheelchairs):~~

~~3.15.3 The height of one or maximum two cushions are limited to 15 cm in playing conditions with no other addition to the wheelchair.~~

6.2. DEFINITIONS OF TERMS AS USED IN THIS DOCUMENT

Approval The certification for conformance to the technical standards as set by the ITTF, for shared playing equipment like balls, nets, net gauges, sports floors and tables.

ITTF Lists Lists of ITTF Approved Equipment

Manufacturers Companies producing equipment

Companies Official companies who have a registered brand

Brand Registered brand

Product Particular name used to describe a specific product of a brand.

Testing The series of tests and measurements required to verify quality, safety and compliance with ITTF requirements in order to get approval by the ITTF.

Re-testing Any repeated testing either because of a prior failed test, of a periodically scheduled quality inspection, or of a problem with a specific model.

Full testing Full testing includes all tests and measurements defined in the manuals.

Partial testing selects the tests and measurements needed for the purpose of the testing.

Quality All regulations and measures targeting to provide customers and users with the assurance best- quality equipment, manufactured in full respect of ITTF technical and safety standards and marketed/labelled in a complete, non-misleading way.

Final Approval The equipment item fulfils all ITTF requirements.

Withdrawal Approval discontinued, when requested by the brands.

Suspension Approval provisionally or temporarily discontinued, when decided by the ITTF.

Deletion Approval permanently discontinued, when decided by the ITTF.

Infringement Any action of violation of the ITTF policies, laws and regulations.

Propositions & Resolutions to the 2026 ITTF Council

Rationale:

1. THE ITTF QUALITY PROGRAM FOR TABLES

- a) *Net gauges are table tennis related equipment, that should be tested and approved by ITTF. Especially when in use at ITTF or any other international level events.*
- b) *Will be described in section STANDARDS. Double information not required.*
- c) *No need for this sentence, as the document will be changed to Manual that regulates the net gauge approval*
- d) *Change of Technical Leaflet to Manual.*
- e) *General information, similar as other Manuals*
- f) *General information, similar as other Manuals*

2. STANDARDS TO ACHIEVE

- a) *Change the wording from light and heavy to the functional name "Standard" and Tension". More practical for Equipment Department to handle. This change will lead through the full document.*
- b) *Crossed out section, is described in the 2nd section under this paragraph. Double information not required.*
- c) *General information, similar as other Manuals.*
- d) *More practical wordings how the approval is working. A manufacturer date is not required on the net gauge after consulting different manufacturer and understanding, that they will only have one mould for the net gauge and not producing more than one net gauge model. To have 172,5 mm indication and 150 mm wheelchair cushion ruler is only optional.*
- e) *General information, similar as other Manuals*
- f) *HMO 7.7 not anymore existing*
- g) *Basic requirements have been split into two tables; one for standard net gauge and one for net tension gauge*
- h) *Only design and position changes of the dimensions of a standard net gauge.*
- i) *Design and position changes of the dimensions of a net tension gauge. And change of tolerance for 100 gramm weight, as manufacturer cannot guarantee a 0.5 g tolerance. After exchange 1 gramm would be more practical*
- j) *Re-new the marking section to fit into the approval system (e.g. that brand name is required, to identify if the net gauge is on the approval list) + specify the relevant dimensions that shall be displayed on the net gauges.*

3. TESTING – PROTOCOL

- a) *General information, similar as other Manuals, updated for net gauges.*
- b) *Information about prohibited appearances of the net gauges. That the lateral incisions must be 4 mm or 2 mm is described before under STANDARDS as a requirement and therefore not required to mention that a net gauge should not have other values than 4 or 2 mm.*
- c) *Updated information related to the dimension testing and used device.*
- d) *New information related to the weight testing and used device.*
- e) *Update to more practical wordings.*
- f) *General information, similar as other Manuals.*
- g) *General information, similar as other Manuals.*

6. ANNEX (only for terms of reference for voting)

- a) *Updated the ITTF Statutes related reference, as it has been changed in the past years.*
 - b) *General change for the naming of the net gauges, that is why it should be changed in the M2 – Net Assembly as well. A separated proposition for this change is submitted as well.*
 - c) *The regulations have been canceled within the Para TT Directives. But that the net assembly should carry 150 mm ruler is still practical for umpires and referees.*
-

Propositions & Resolutions to the 2026 ITTF Council

Proposition IC-07

(Simple majority required)

Proposed by the ITTF Equipment Committee

To modify the MANUAL M9 – RACKET CONTROL:

7. DISMANTLING RACKETS

7.1. PROCEDURE

- a) Dismantling of rackets is not part of the umpires' after-match duties and should be performed by trained racket testing staff and in the racket control room, only. The referee will be called to the racket control room, **double check the findings of the racket tester** and decide based on ~~the~~ **these** measurement results ~~by the racket tester~~ whether dismantling is required or not.

[...]

- ~~b) With the rubber surface of the racket, it looks like the pimples come to the surface and the rubber edge bends outwards.~~

~~The appearance of the blade is leaving doubts about its carving to the umpire who checks the racket in the Call Area but cannot be proven legal/illegal unless examined separately~~

Rationale:

- a) *There was a request from Athletes Committee to clarify once again, that the referee should control the results of the racket tester before calling the player. "Double checking of the racket testers finding" means that the referee is carefully listen to the results and the interpretation of the racket tester and if needed, repeat or let the measurements repeat in front of her/him. This includes all testing methods that lead to the decision of calling the referee.*
- b) *Both points are indeed no inspections where a digital value can be defined. They are part of indications for the racket tester to inspect the racket more detailed. The two paragraphs will be canceled out of the M9.*
-

Propositions & Resolutions to the 2026 ITTF Council

Proposition IC-08

(Simple majority required)

Proposed by the ITTF Technical Commissioner and the ITTF Event Department

ITTF World Youth Championships – Team events – Playing System

Team Events will be played in two stages.

Stage 1: Groups (round-robin). Stage 2: Main Draw (knockout)

Team match is played in best of 15 games. Individual matches are played in 3 games (with results 3-0 or 2-1), unless one of the teams wins 8 games. In this case the match is concluded.

A team shall consist of 3 players.

Order of play:

1. Doubles: B/C v X/Z
2. Singles: A v Y
3. Singles: C v X
4. Singles: A v Z
5. Singles: B v Y

The draw will be conducted according to the ITTF Regulations for groups (round-robin) based on the modified snake-system and for the main based on knockout basics.

It is proposed to implement the proposition from the ITTF World Youth Championships 2027.

Rationale: To ensure that all teams taking part in the ITTF World Youth Championships have the chance to play a minimum of 2 matches. The system has been successfully implemented in the ITTF Mixed Team World Cup, ensuring very competitive matches and a reduction on the duration of the team matches.

Propositions & Resolutions to the 2026 ITTF Council

Proposition IC-09

(Simple majority required)

Proposed by the ITTF Technical Commissioner and the ITTF Event Department

ITTF World Youth Championships – Doubles and Mixed Doubles events – Qualification System

It is proposed to amend the qualification pathway of the Doubles and Mixed Doubles events of the World Youth Championships. In addition to the existing policy “Players qualified in Singles events are entitled to participate in Doubles and Mixed Doubles events of the respective age category that are qualified in Singles.”, add “Member Associations (MAs) with a team qualified will be entitled to alternate players to participate in Doubles and Mixed Doubles events in the same age category that players from the respective MAs are qualified in Singles”.

It is proposed to implement the proposition from the ITTF World Youth Championships 2027.

Rationale: In order to ensure the highest level of competition and the opportunity for more Youth players to play in the Individual events, it is recommended that MAs can alternate players for participation in Doubles and Mixed Doubles events, and not necessarily to enter the ones playing in Singles event.

Propositions & Resolutions to the 2026 ITTF Council

Resolution IC-10

(Simple majority required)

Proposed by the Member Association of Iraq (IRQ)

Regarding the Review of the Participation System in the World Table Tennis Championships.

First: Introduction

Based on the commitment of the Iraq Table Tennis Federation, as a national federation and a member of the International Table Tennis Federation, to the development of the sport worldwide and to ensuring fairness of opportunity among all member associations, we hereby submit this proposal to review and reformulate the current participation system in the World Table Tennis Championships, in a way that balances high competitiveness with international inclusiveness.

Second: Advantages of the Current System

The Iraq Table Tennis Federation appreciates the efforts made by the ITTF in developing the World Championships, and acknowledges that the current system has achieved several positive outcomes, among the most notable of which are:

- Raising the technical level of the final stages and increasing competitiveness among elite players and teams.
- Reducing the duration of the championships and organizing the schedule more efficiently.
- Enhancing the media and commercial value of the event.
- Relying on the world ranking as an objective technical criterion.

Third: Disadvantages of the Current System

However, we believe that the current system has also created some challenges, particularly for developing associations, including:

- Excluding a large number of member associations from effective participation in the World Championships.
- Reducing international exposure opportunities for players from developing countries, which limits their technical progress.
- Widening the technical gap between advanced and emerging associations.
- Decreasing grassroots and investment motivation in some countries due to the lack of opportunities for global participation.
- Transforming the World Championships from an inclusive global event into a competition with limited elite representation.

Fourth: The Proposal

The Iraq Table Tennis Federation proposes the following:

- Reintroducing a comprehensive participation system that allows all member associations to take part in the World Championships, by:
- Dividing teams and players into levels (Divisions) according to their technical strength.
- Applying a promotion and relegation system between divisions in team events.
- Maintaining a high level of competition in the final stages by:
- Keeping the top division (Division A) reserved for the highest-ranked countries.
- Allocating lower divisions (B – C – D) to support the development of emerging associations without affecting the quality of the top championship.
- Studying the possibility of organizing the lower divisions in the same host country, or in a neighboring country, during the same period.

Propositions & Resolutions to the 2026 ITTF Council

Fifth: Expected Benefits of the Proposal

Reviewing the participation system will achieve the following:

- Strengthening the principles of fairness and inclusiveness among all member associations.
- Supporting the global development of table tennis, particularly in developing countries.
- Expanding the player and fan base of the sport internationally.
- Preserving the identity of the World Championships as a truly global event.
- Creating a clear and sustainable development pathway for small and medium-sized associations.

Sixth: Conclusion

The Iraq Table Tennis Federation affirms that this proposal is presented within the framework of constructive cooperation with the International Table Tennis Federation, and with the aim of serving and developing the sport in the long term. We hope that this proposal will receive due consideration and discussion within the relevant committees.

Rationale:

This proposal is based on the need to restore balance between competitiveness and inclusiveness in the World Table Tennis Championships. While the current ranking-based system has strengthened elite competition, it has also limited participation opportunities for many developing member associations, reduced international exposure for their players, and widened the technical gap. The proposed divisional participation model seeks to ensure fair global representation while preserving the high level of competition in the top division.

Propositions & Resolutions to the 2026 ITTF Council

Resolution IC-11

(Simple majority required)

Proposed by the Member Association of China (CHN)

The relevant departments, including but not limited to the Equipment Committee and the Umpires & Referees Committee, shall collaborate to revise and clarify the specific procedures and standardized operational requirements for racket control, ensuring their implementation within six months. Specifically but not limited to the following aspects:

- a) Standardized, rigid storage devices—such as transparent plastic boxes—must be used to contain and store tested rackets.
- b) From the moment a racket is deposited at the call area until it is handed over to the player at the match table, the entire process must be monitored via video surveillance, recording, or other traceable supervision methods.

It must be specified that players or their accompanying personnel have the right to observe and supervise all stages of the racket control process.

Rationale:

Currently, neither the racket control workflow description nor the racket control manual provides adequate operational guidelines for handling players' most important piece of equipment. These documents also fail to clarify the rights of players or their accompanying personnel during the control process.

Furthermore, there is reason to believe that paper envelopes or bags are insufficient to protect rackets from accidental damage, particularly in doubles and team events where one umpire may need to carry up to four or six rackets simultaneously.

This resolution aims to reinforce bilateral supervision over equipment handling and inspection, uphold players' rights, and establish a strict accountability system to prevent malpractice and deliberate damage.

Propositions & Resolutions to the 2026 ITTF Council

Resolution IC-12

(Simple majority required)

Proposed by the Member Association of China (CHN)

In the process of composing the Sport Specific Information and relevant technical documents for the mixed team event at LA28, it should be clearly stipulated that for each team match, each participating team must deploy three men's and three women's athletes.

This differs from previous men's and women's team events, where teams were allowed to compete with only two male/female athletes to for one team match.

Rationale:

In LA28, singles events will feature one athlete, doubles events involve two athletes. Team events should be distinctly different from individual events, requiring all three athletes per gender to compete in order to showcase the diversity of team tactics, playing styles, and techniques of table tennis.

The establishment of the mixed team event is rooted in the principles of teamwork and gender equality. Whether in the overall team lineup or in each individual match within the team competition, this philosophy should be emphasized, providing equal attention and opportunities for both male and female athletes on the Olympic stage.

Furthermore, teams qualified for the mixed team event in LA28 will all have officially registered three male and three female athletes each. Additionally, team quotas will include alternate (Ap) athlete quota to account for special circumstances and injuries. Thus all qualified teams will be fully equipped to meet the aforementioned requirements.

If a team were allowed to compete with only two male or female athletes, or if both competing teams were to do so, it would negatively impact the scheduling and match arrangements of the entire competition.

[This page has been intentionally left blank]



ITTF QUALITY PROGRAMME

FOR TABLES - MANUAL 1



September 2025



1. INTRODUCTION
 - 1.1 ITTF LOGO & TRADEMARK
 - 1.2 CONTACT

2. STANDARDS TO ACHIEVE
 - 2.1 PRODUCT & BRAND
 - 2.2 MATERIAL OF THE PLAYING BOARD
 - 2.3 MANUFACTURING
 - 2.4 APPEARANCE
 - 2.5 SPECIFICATIONS
 - 2.6 ADVERTISEMENTS/MARKINGS ON TABLE

3. TESTING - PROTOCOL
 - 3.1 TESTING PROCEDURE
 - 3.2 TESTING INSTITUTE
 - 3.3 SERVICES

4. APPROVAL - REQUIREMENTS
 - 4.1 GET APPROVED
 - 4.2 STAY APPROVED
 - 4.3 CHANGES
 - 4.4 WITHDRAW APPROVAL
 - 4.5 REINTEGRATION OF TABLES
 - 4.6 FEES
 - 4.7 PENALTIES

5. EXPLORE - LIST
 - 5.1 LIST OF ITTF APPROVED TABLES

6. ANNEX
 - 6.1 TERMS OF REFERENCE
 - 6.2 DEFINITIONS OF TERMS AS USED IN THIS DOCUMENT



1. INTRODUCTION

High performance in modern sport cannot be achieved without good equipment. Although the expert and the beginner require different degrees of excellence, both need equipment of a consistent and safe standard. Perhaps the most important item of table tennis equipment is the table, for with a bad model that produces abnormal, irregular or unpredictable bounces not even enjoyment can be obtained.

The International Table Tennis Federation tests and approves tables, thus setting a high standard for sporting quality and safety during international competitions. Information and instructions for applying for or renewing ITTF approval of tables and information about the approval procedures are established by the ITTF as an appendix to the present Manual and are, available to Associations and manufacturers from the ITTF Website.

New tables are approved only provisionally for the first year after their first use at a tournament listed in the ITTF calendar; during this period the approval can be cancelled by ITTF if they receives adverse comments and a re-test at the brand's expense shows that the table does not meet ITTF specifications.

1.1. ITTF LOGO AND TRADEMARK

The ITTF approved tables are identified by their brand names and by the ITTF logo, or other ITTF indications. They must wear the ITTF logo wherever they are sold or used! All names must be in Roman or Latin letters, and additionally they may be in another language. The name may contain numbers.

The ITTF will make its best effort to ensure that the trademark or brand name does not infringe on the already existing table brands. The ITTF is not responsible for any illegal use of registered trademarks. Verifying the correct and legal use of trademarks is not part of the ITTF approval procedure.

1.2. CONTACT

ITTF Equipment Office
Kaesenstrasse 17
50677 Cologne - GERMANY
Tel: +49 221 42343366
E-mail: equipment@ittf.com

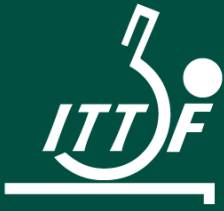

STANDARDS





2. STANDARDS TO ACHIEVE

A brand may have ITTF approved tables differing in:

- colour i.e. blue, green or additional colours
- table type i.e. non rollaway or rollaway
- table commercialization i.e. standard or showcourt
- product name which may be different when specifications are different
- tabletop friction range i.e., friction range I, II or III

2.1. PRODUCT AND BRAND

Each table must have a specific name that distinguishes it from any other table.

The name of a product is always composed by the brand name and the product name. Both together define the product in a unique way so that confusions will be avoided and consumers are correctly informed.

A substantially changed or a new product must bear a name which is different from a name that is presently used or has been used during the past 10 years for the same type of table.

Tables, whose tabletops are different or made in different factories, must have different names. Tables with the same tabletop and with a similar or nearly identical undercarriage may have the same name, if agreed by ITTF.

A second version of a table that is re-designed to be suitable for wheelchair play can have the same name as the original version but with the letter W added.



2.2. MATERIAL OF THE PLAYING BOARD

For general use the tabletop board may be of any continuous material; tables are available with tops of plywood, particleboard, plastics, metals, concrete or fibreglass. Since the finish governs the frictional properties more than the substrate does, a broad spectrum of materials can be used so long as the bounce is suitable; this point is discussed in a later section.

For major tournaments, however, only wood or wooden derivatives may be used for the playing board, and the ITTF therefore approves only wood or its derivatives.

Wood is a natural product susceptible to the effects of moisture, and the dimensions and shape of the table can therefore change according to humidity. Most manufacturers have found methods of construction that minimize these changes, but some variation is unavoidable.

ENVIRONMENTAL AND HEALTH ASPECTS OF MATERIAL

The selection of materials for the production of a table shall not only value aspects of mechanical properties, processing ease, reduced costs and design, but also consider the health of the workers and consumers and take into account the environmental impacts during manufacturing and discarding.

No part of the final table shall contain or release harmful substances:

- The content of formaldehyde of wood and wooden materials shall not exceed the mean value as determined in European standard E1 or similar other norms.
- Plasticizers like DEHP, DBP and BBP may not be used during manufacturing. No residues of the mentioned plasticizers or of other softeners like DIND, DIDP, DNOP or similar chemicals suspected for having allergic, asthmatic or hormone-disrupting properties shall remain in the final product.
- The final table shall not release VOC and its paint or finish shall not contain toxic pigments or binders that may be unhealthy for the user. Before being delivered to the market the table shall be stored and aired long enough in order to no more release VOC.

The approval scheme may require the brand to submit certificates related to the above-mentioned health requirements; ITTF may check their truthfulness.

Environmental considerations shall include:

- Reduce nuisances (noise, vapours, etc.) for the workers during production.
- Do not release harmful products to the air or water during production.
- Reuse and recycle as much as possible.
- Use risk-free packaging material and reduce its quantity as much as possible.
- Use materials for the table that can be safely disposed and even recycled at the end of the table's life; instruct the consumers accordingly.



2.3. MANUFACTURING

ITTF recommends manufacturers and brand to strictly apply the technical and other legal regulations of the user's home countries. The ITTF cannot be held responsible in case of non-observance of any additional or different national request; the ITTF approval sets up ITTF standards guaranteeing a safe and reliable table tennis at top-level events.

Currently the following national standards have been brought to the attention of the ITTF: CEN/TC - prEN 14468-1 and prEN 14468-2 (Europe), JIS-S-7008 (Japan), GB7902-1987 (China).

New materials, new manufacturing processes or a change of the producer, what could result in different properties, need to be announced to ITTF and require new testing.

2.4. APPEARANCE

The appearance of the table, although important, is difficult to specify and only some items will be pointed out. It should be noted, however, that the purpose of ITTF approval is to determine which items of equipment are suitable for top-level play, particularly international. Such play is normally held in front of spectators, and often before TV cameras that transmit their images to millions of people in dozens of countries. This medium is the sport's best source of advertising; all aspects of the presentation must be on a professional level, including the appearance of the table.

Paint, colour or gloss irregularities that are visible to the naked eye are not acceptable. The paint must be firmly bonded to the substrate, it should neither colour the ball nor look scuffed or scratched.

A table that for some reason looks home-made, flimsy or cheap, regardless of the playing qualities of the tabletop, will not be given approval.

The table should look safe and not have dangerous or harmful protruding parts. There shall be no sharp edges or corners, except on the table surface, and no raspy surfaces or shear points.



2.5. SPECIFICATIONS

1. Definitions
2. Types of construction
3. Table dimensions
4. Colour/Gloss, Finish, Lines and Friction of tabletop
5. Safety requirements
6. Wheels and brakes
7. Net attachment area
8. Permanent net posts
9. Undercarriage
10. Table skirting
11. Tables for young players
12. Tables for wheelchair play
13. Show-Tables

2.5.1. DEFINITIONS

Tabletop	Half of a table, divided at the net, including the playing board, the finish and lines of the playing surface, the frames and other reinforcements under the board especially around its edge and side, the markings on the frames and any device holding or attaching together both halves and, in general, any other part attached to and moving with the tabletop, but without any part of the undercarriage.
Full tabletop	Two tabletops assembled in the playing position.
Undercarriage	All the parts whose principal function is to support the tabletop including the wheels attached to the undercarriage and the legs.
Playing position	Both tabletops in the horizontal position with the net assembly attached (figure 1).
Playback position	One tabletop in the horizontal position with the net assembly attached and the other one in the vertical position
Storage position	Both tabletops in the vertical position (figure 2).
Net assembly	Net, its suspension and the supporting posts, including the system attaching it to the table.
Players' safety area	Area in which all parts of the undercarriage have to comply with the specific requirements preventing the moving player from getting hurt (figure 11).



E and N

E is defined as the table end and N as the net end of the table.

W

This letter stands for wheelchair table. It will appear after numbers in the diagrams to show that this drawing is for a wheelchair.

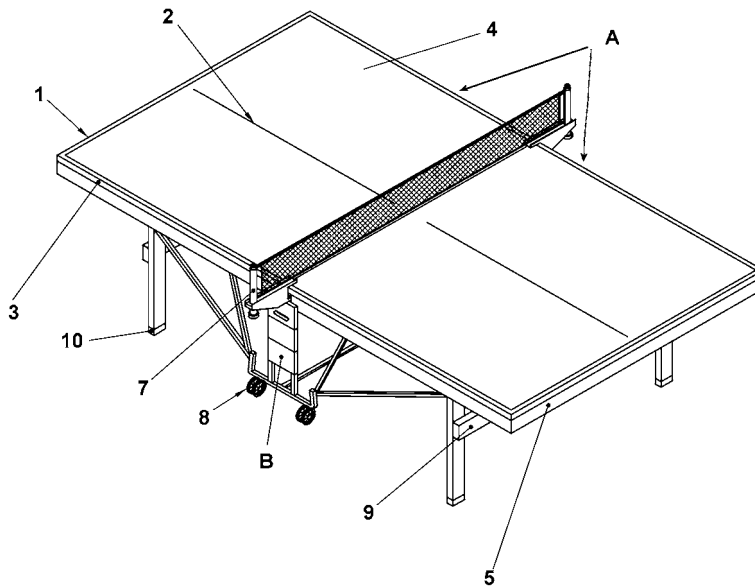

Figure 1: Playing position

A Tabletop

- 1 End line
- 2 Centre Line
- 3 Sideline
- 4 Playing board + surface
- 5 Frame
- 6 Trademark, Table name, ITTF logo
- 7 Net assembly, net attachment area

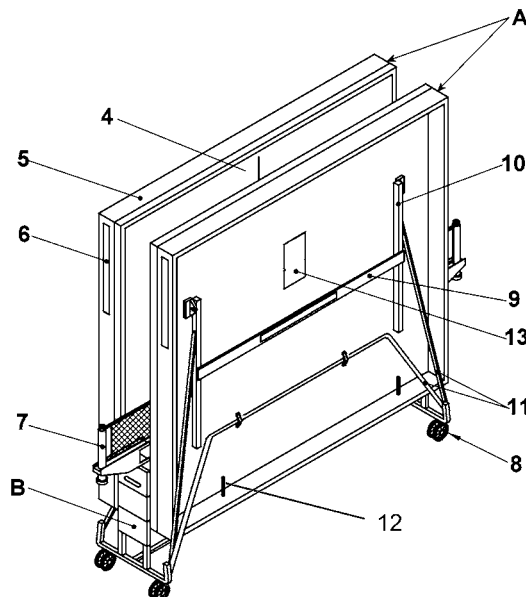

Figure 2: Storage position

B Undercarriage

- 8 Wheel
- 9 Cross bar or cross-bracing
- 10 End leg
- 11 Strut
- 12 Safety device or lock
- 13 Operation and safety instructions
- 14 safety area (see figure 11)



2.5.2. TYPES OF CONSTRUCTION

Currently four types of tables may be considered:

TYPE (I)

Non rolling tables, i.e. stationary tables without wheels at the bottom of the undercarriage. They may have an undercarriage that, in the storage position, is not attached to the tabletop or they may be made up by two separate tabletops both with a folding undercarriage.

Figure 3: Table type I

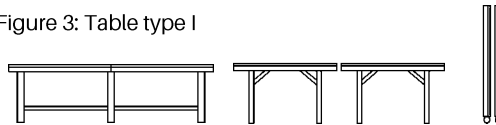

TYPE (II)

Rollaway tables with two tabletops, each with an own separate folding undercarriage.

Figure 4: Table type II

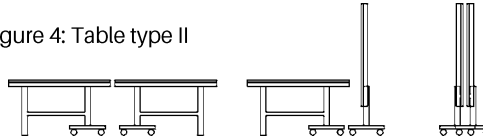

TYPE (III)

Rollaway tables with one undercarriage and two tabletops that can be folded independently from each other.

Figure 5: Table type III



TYPE (IV)

Rollaway tables with one undercarriage whose tabletops always fold in and out together.

Figure 6: Table type IV

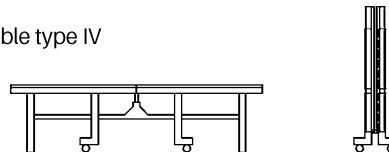



2.5.3. TABLE DIMENSIONS

	Code	Description	Dimension [mm]	Fig.
Distances in the longitudinal direction [l]	l_1	length of the table	2740 ± 5	7
	l_2	inset of the end legs from the table end	≥ 150	9
	l_3	distance of the end legs from the table end for use of wheelchair players	≥ 400	9
	l_4	length of the player's safety area (starting at the table end toward the net end)	≥ 800	11
	l_5	width of a central part of the undercarriage that extends beyond a tabletop side (no advertisement permitted)	≤ 200	11
	l_6	gap between the two tabletops in the playing position (tables type III and IV)	≤ 20	7
	l_7	gap between the centreline and the middle edge of the table	≤ 50	7
	l_8	gap between the centreline and the end line	≤ 10	7
Distances in the transvers direction [b]	b_1	width of the tabletop	1525 ± 3	7
	b_2	inset of the end legs from the side of the tabletop	≥ 100	10
	b_3	extension of the middle section of the undercarriage beyond the side of the tabletop	≤ 60	11
	b_4	gap between a folding leg and the frame	≥ 15	14
	b_5	extension of a wheel beyond the side of the tabletop in its unfavourable position	0	14
	b_6	width of the side and also end lines	20 ± 1	7
	b_7	width of the centreline	3 ± 1	7
	b_8	alignment of both tabletops and their centrelines	≤ 2	8
Distances in the vertical direction [h], on an even floor (if relevant)	h_1	height of the table	760 ± 3	9
	h_2	distance between a side crossbar and the floor within the player's safety area (see l4)	≥ 200	9
	h_3	distance between an end crossbar and the floor	≥ 300	10
	h_4	distance between the playing surface and any extension of the middle section of the undercarriage or permanent net supporting post	≥ 12	9
	h_5	distance between the middle section of the undercarriage and the floor	≥ 50	9
	h_6	thickness of the batten plus the top	≤ 100	9

Table 1: Dimension of the table [mm]



2.5.4. COLOUR/GLOSS, FINISH, LINES AND FRICTION OF TABLETOP

COLOUR/GLOSS

The playing surface of an ITTF approved table must have a dark colour, whose lightness L in the CIELAB system must not be more than 40%. ITTF may tolerate lightness up to 44%, if the appearance and colour of the surface remains dark. It must be matt, with a degree of gloss not more than 15 (60° specular gloss, ASTM procedure D 523) and a low haze-gloss. A change of the paint may affect the friction, the gloss and the bounce; it requires testing.

It may be reminded that about 8% of the male population, with North European ancestors, have problems in distinguishing green and red.

FINISH

The finish must be uniform over the entire surface; it must therefore be applied in some uniform manner such as spraying, roller or curtain coating or similar; brush marks are unacceptable. The finish will also be unacceptable if, regardless of the measured degree of gloss, it permits the shape of a light-source to be distinguished in its reflection.

The surface must be even and regular, with no inlaid dust and no projecting particles of pigment.

The finishes may not transfer surface pigment to the ball. This causes concern to players, spectators and TV crews. A suitable choice of finish may eliminate this problem completely. Other finishes undergo a hardening process that takes days or weeks; manufacturers who use this type usually store their tables for long enough to permit this process to take place so that their tables do not colour the ball.

LINES

In addition to the principal finish, the playing surface must be marked with white side-lines, end lines and centrelines (b_6 , b_7 , l_7 and l_8). The difference in level of all lines should not be detectable by the fingers, and in no case shall it be measurable.

FRICTION (ACTIVE FROM 01.01.2025)

The tables with different coloured tabletops are grouped into 3 categories of friction (in terms of using the same spin-stroke).

FRICTION RANGE	COEFFICIENT OF FRICTION (CoF)	
	min	max
I	0.150	0.210
II	0.211	0.270
III	0.271	0.350

I.e., it may happen, that a brand's tabletop colour "blue" could be grouped to another friction range, different from their tabletop colour "green" or "another colour".

It is the brands and manufacturer's responsibility to keep the CoF of an approved tabletop within the same friction range.



2.5.5. SAFETY REQUIREMENTS

In the storage and in its rolling or playing position, the table must meet the highest possible safety standards in order to avoid dangerous and inadvertent displacement, unfolding or collapse and to prevent players from being hurt.

It is important that the players feel safe and confident with the design of the table.

The following requirements describe the standards as required by ITTF; if a country's legislation enforces additional or other measures, its regulations prevail on that territory.

If a player, or anything he wears or carries, moves the playing surface, his opponent scores a point (Law 2.10.1.8). In case of a violent shock or a heavy load, the table should not collapse nor tilt. Although the ITTF does not stipulate minimum distances between the points of the undercarriage touching the ground, the table or table half of tables type (II) must be rigid, stable and sturdy enough to endure without being damaged or tipping a brusque or longer sitting-down of a person on its top and a slight sway of the seated person, but its legs and cross bracing must not obstruct the players' feet.

2.5.5.1. PLAYING POSITION

In the playing position each table half needs 4 legs, except if its tabletop or the tabletop supporting block is made of one solid piece or if its halves are strongly sealed together. The sides or cross section of the legs shall be less than 15cm (see figure 10).

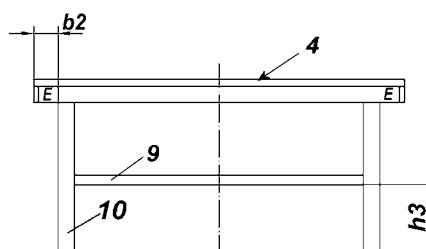

Figure 10: Table front-view

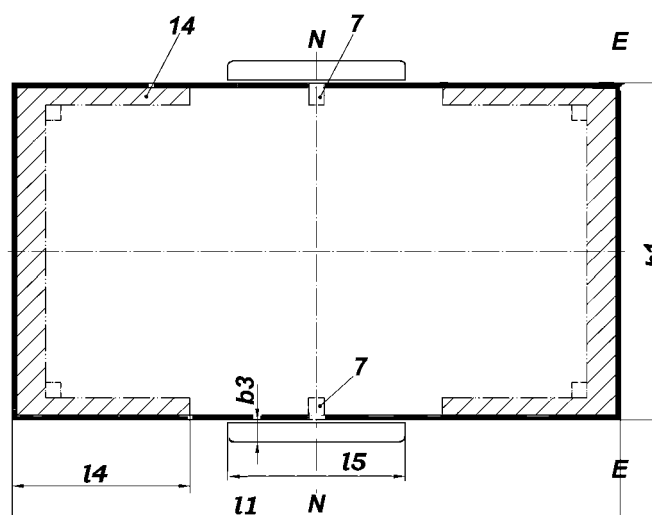

Figure 11: Safety areas in playing position

A horizontal bar of the centre leg supporting a wheel is not considered as cross bracing. In case of an undercarriage whose sides and ends touch or nearly touch the floor, the following restrictions may be observed: The space between the heights 0 and $h_3 = 30\text{cm}$ may be closed following a line, called skirting line, inset from the table end 38cm at the floor and 10cm at the tabletop (see figure 12) and the space between the heights 0 and $h_2 = 20\text{cm}$ may be closed following a line inset from the table side 18cm at the floor and 5cm at the tabletop (see figure 13).

An asymmetric design of the undercarriage resulting in structural differences at the safety area(s) shall observe all relevant requirements of dimensions and safety, and permit the server placing his feet the same way, whatever side or end he chooses for serving.

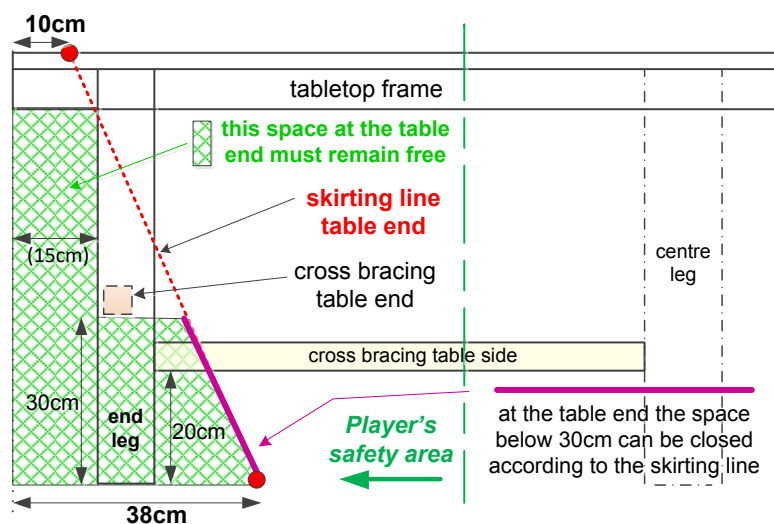

Figure 12: Safety area table side-view

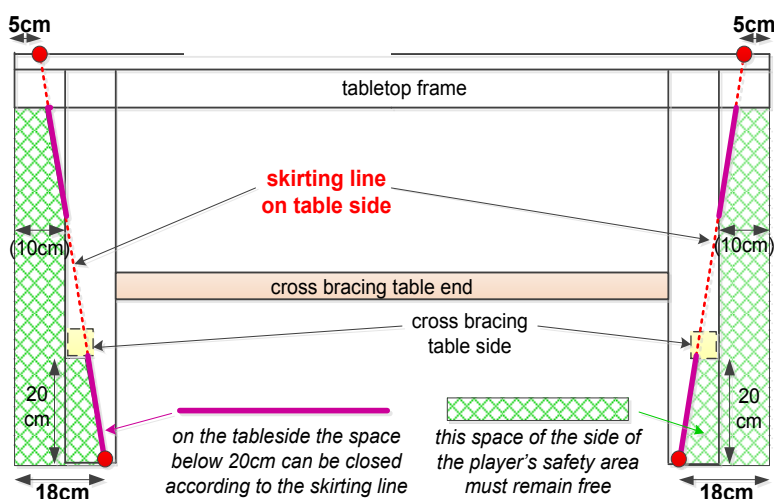

Figure 13: Safety area table front-view



For tables type (I) and (II), the resting or fixation points of the tabletop at the supporting framework of the undercarriage or directly at the legs may be inset not more than 25 cm from the table end and 15 cm from the table side. Resting or fixation points must be exactly the same for both table halves. The design, strength and rigidity of the table undercarriage must ensure that the tabletop is showing no undesirable unbalancing, no see-sawing, no swinging and no vibrating risks or effects that may affect the players' or officials' confidence.

Elastic layers between tabletop and undercarriage are not allowed. Dampers used for an easier set up of these tables may not cause bobbing up and down or vibrating risks at the tabletop ends.

At the net area of the tabletops an *extension of the undercarriage of rollaway tables* beyond the sidelines is allowed (see figure 14 and table 1). All edges and corners must be rounded and its construction may not hurt the players' feet.

Under the net, any hinge or other joint attaching both tabletops together must not extend more than 5 mm above the playing surface.

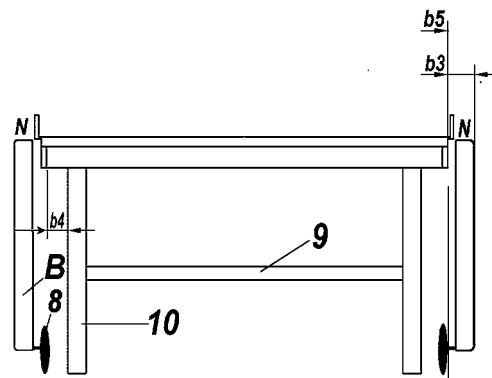

Figure 14: Extension of the undercarriage of rollaway tables (II, III and IV)

SAFETY DEVICES IN PLAYING POSITION

Suitable safety devices must lock automatically, except for table type (I), and their unlocking must need a deliberate act or the application of a large force.

Each half of a non-rolling table that has folding legs must have at least two locking devices that firmly block the legs in the playing position. Locking may be either manual following simple instructions, or automatic.

If a locking device is needed to give the rollaway table the requested rigidity and stability, it shall lock automatically and safely when the tabletops are unfolded on a flat horizontal ground.



2.5.5.2. STORAGE POSITION

A table in a storage position or being moved from one place to another shall be safe with regard to

- inadvertent unfolding of its halves or undercarriage
- tilting and collapsing
- inadvertent rolling away

A table while being set up may

- not tip over or collapse
- not demand to a high skill or strength of one single person.

All fixings, hinges and joints must be strong and secure in order to withstand without damage the rolling of the table over an uneven pavement, for instance a tiled floor. The undercarriage shall not get out of shape under the same conditions. All parts shall sustain without damage the endurance test as described at the end of the manual.

SAFETY DEVICES FOR TABLE TYPE I (NON-ROLLING)

The undercarriage of a non-rolling table may not fold out when the table half is moved. Each pair of braced legs or each leg must therefore be kept folded by a manual or automatic locking device, which may be unlocked only manually.

SAFETY DEVICES FOR TABLE TYPES II, III AND IV (ROLLAWAY)

The table halves of a rolling table must be held up by means of safety devices so that unintended folding out will be prevented in both storage position and moving, also on an uneven or sloping floor.

The safety bolts or catches of each table half must be built and placed in such a way that:

- their locking is automatic, easy and safe.
- their manual unlocking demands two deliberate, not-continuous actions requiring either skill or force.
- their unlocking & the safe unfolding of a tabletop or table is possible for one or two persons.

The locking devices must always be delivered completely assembled. They should preferably be affixed to the table; if this is not the case, the customer must be instructed to easily and safely attach it without any doubt or error.

Normally two different locking devices must be used; at least one of them must not be a gravity-catch. If the gap between the raised tabletops is less than 11 cm and if the traction requested for unfolding a not locked tabletop requires a force higher than 25 N, the tabletop of the rollaway table may be secured by one locking device only, which needs two not-continuous actions to unlock it.

The legs of a rollaway table half shall extend automatically, i.e. without needing to be pulled, when the top is folded down. The table in its storage position should be as narrow as possible.

PREVENTING DEVICE FOR TABLE TYPE III

A rolling table type (III), whose raised tabletops up to 76 cm are more than 11 cm away from each other, must be equipped with a device preventing the intrusion of a child into this gap in order to avoid that



the head or trunk could be squashed by an unfolding tabletop. This protecting system should be designed in a way to bar the access to the gap from the bottom and from the top, in the storage as well as in the playback position.

LOCKING DEVICES AND SYSTEMS & UNLOCKING ACTIONS			
Table type	Unit locked	Minimum number and type required	Deliberate action(s) for unlocking the locks
(I)	No folding legs	no locking device is required	
	Legs folding individually	1 locking device for each leg	1 action for the device
	Legs folding as pairs	1 locking device for each pair	1 action for the device
(II)	Tabletop	2 locking devices, located more than 90 cm apart, one not based on the gravity principle	1 action for each device 1 action for the two devices together taking place less than 35 cm from the tabletop end
		if tabletop-unfolding force > 25 N: 1 locking device, not based on the gravity principle	2 not continuous actions for the device
(III)	Tabletop With a gap between the 2 tabletops in the storage position \geq 110 mm	2 locking devices, located more than 90 cm apart, one not based on the gravity principle	1 action for each device
		1 locking device, not based on the gravity principle	2 not continuous actions for the device, not possible from between the tabletops in storage or playback position
	Tabletop With a gap between the 2 tabletops in the storage position < 110 mm	2 locking devices, located more than 90 cm apart, one not based on the gravity principle	1 action for each device 1 action for the two devices together taking place less than 35 cm from the tabletop end
		if tabletop-unfolding force > 25 N: 1 locking device, not based on the gravity principle	2 not continuous actions for the device
(IV)	Table	2 locking devices one not based on the gravity principle	1 action for each device, both actions shall take place less than 35 cm from the tabletop end, or one of them may be achieved by foot 1 action for the two devices together taking place less than 35 cm from the tabletop end or by foot
		if table-unfolding force $25 > F \leq 60$ N: 1 locking device not based on the gravity principle	2 not continuous actions for the device
		if table-unfolding force > 60 N: 1 locking device	1 action for the device taking place less than 35 cm from the tabletop end or by foot
Unfolding is <u>not</u> an unlocking action. Unfolding force is the pulling force needed to unfold the unlocked tabletop (types II & III) or table (type IV) by applying a horizontal force at the top of a raised tabletop.			

Table 2: Locking units and their action in storage position



2.5.6. WHEELS AND BRAKES

TABLE TYPE I (NON-ROLLING)

Two small but substantial caster wheels, fixed on or inset into the batten under the net end of the table half, may permit rolling the table half instead of carrying it. Recommended minimum specifications for these wheels on type (I) tables are as follows:

Dimensions for wheels (table type I) [mm]	
Caster wheel diameter	≥ 50
Width at contact with floor	≥ 20
Clearance between table and floor	≥ 20

TABLE TYPES II, III AND IV (ROLLAWAY)

As many swivel-wheels as possible should be used. For an undercarriage with four wheels, at least two shall swivel. For an undercarriage with three wheels not in line, at least one shall swivel. If the castor wheels of a table half are all in line, no one must swivel; an only wheel must not swivel.

The wheels should permit *safe* rolling over uneven floors. The wheels should not damage the sports floor; in order to preserve the 760 mm table height, they should not indent the synthetic and rolled types of flooring.

Dimensions for wheels (table types II, III and IV) [mm]	
Wheel diameter	≥ 75 (easier and safer: > 90)
Width of single wheel	≥ 20
Width of twin wheels	≥ 30

The manufacturer should take in account also the reduction of the wheel diameter because of the compression of the tyre material. The wheels may *not* have *sharp or abrasive* lines or edges.

BRAKES

Half of the wheels should carry an easily adjustable *brake*, thus preventing rolling away on a slope. The following recommendations should be considered for the location and quantity of the brake wheels (exceptions for special constructions can be made):

- Rolling tables type (II): ~~brake wheels on the furthest end from the player.~~ At least 2 brakes per table half, 1 brake on table half left and right side. Location of the brakes should be symmetrical.
- Rolling tables type (III): brake wheels diagonally opposed. At least 1 brake per table half.
- Rolling tables type (IV): ~~brake wheels under one tabletop only.~~ brake wheels diagonally opposed. At least 1 brake per table half.

The rolling devices should be solid and durable; they should sustain without damage the endurance test as described at the end of this chapter.



2.5.7. NET ATTACHMENT AREA

If the edges of the table are reinforced, the battening must be cut away where the net posts are to be attached. At this point, as shown in figure 15, the free space between the battening on the two halves of the table should be at least 70 mm wide, and it should extend under the table at least 100 mm.

If these requirements are met, then the table will accept almost all ITTF-approved net assemblies.

It is desirable that the areas contacted by the clamp surfaces of the net posts, both on the playing surface and on the underside below it, be reinforced to prevent wearing by continual attachment and removal of the posts.

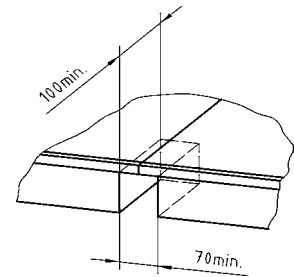

Figure 15: Net attachment area

Metal or fibre-glass inserts at these points represent one means of accomplishing this objective, although protectors on the net posts serve the same purpose. The reinforcements should not considerably increase the thickness of the tabletop. No part of the undercarriage or the battens should hinder easy and safe attachment. Permanently attached nets may not need any specially designed space.

2.5.8. PERMANENT NET POST

Net supporting posts are permanent if they do not need to or cannot be removed when the table is closed for the storage position.

A permanently attached net supporting post can be affixed either to the frame of the tabletop or to the undercarriage or to both. It should accept most of the approved nets and should be designed such that the net can be easily changed should that be necessary.

The horizontal parts (considered as frame-part) and the vertical parts (considered as undercarriage-part) of the net posts and the net attachment must be designed according to the specifications of M2. The horizontal part of the net supporting post must be designed in a way that its sides allow a clear visual distinction between post and attaching or undercarriage parts, and that no part of its upper edge shall be below the level of the table surface.

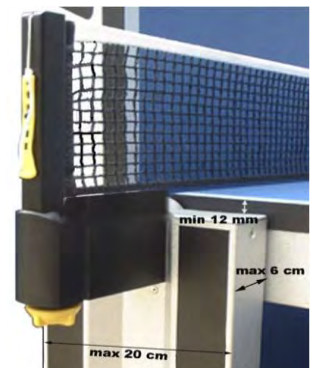

Figure 16: Permanent net post and attachment system

Dimensions of permanent net posts attachment system [mm]	
Width of the horizontal part of net supporting post	≤ 45
Distance between attaching parts and table surface level	≥ 12
Length of left and right parts along table side of horizontal attachment parts (h.a.p.)	≤ 200
Extension of h.a.p. beyond tabletop side	≤ 30
Distance to the table side to prevent dangerous shearing	≥ 15
Extension of vertical attachment parts beyond tabletop side	≤ 60
Traction force used to test upward-, downward- and parallel-to-tableside stability	10 N

The net posts and attachment systems shall be sufficiently rigid to endure strokes and shocks from any direction without showing lasting bending or twisting.



2.5.9. UNDERCARRIAGE

HEIGHT ADJUSTMENTS

Tables of type (I) do not need height-adjustment devices because of their rigid structure. Tables of type (II) to (IV) shall have height-adjustment devices at least at the bottom of their end feet, but preferably also under their net ends. All of these should be easy and safe to handle, to adjust and to fix. A desirable feature permits lifting the table from the wheels on to non-rolling feet, which should be large enough to avoid indenting a sports floor.

COLOUR

The undercarriage should not be white i.e. its lightness L in CIELAB system should not be more than 90 %; its finish must not reflect light upwards, so that the players and the spectators are not dazzled.

UNDER-TABLE LIGHT

Not dazzling under-table light or fluorescent paint may be used to enhance the attractive presentation of a table undercarriage; they shall not affect the sight of players, spectators, officials and cameras neither directly nor by reflection. A switch must be provided in order to power off the light; the switch may also dim.

2.5.10. TABLE SKIRTING

Skirts are removable parts of the undercarriage that are not functional or structural elements of the table, but whose declared ambition is embellishment of the playing table and area.

They shall not adversely affect the requirements of safety, functioning, presentation and sporting properties; once the skirt attached to the table, all dimensions laid down in the present manual must be strictly observed.

The material used may be soft or hard but must not break or tear when a player collides heftily with it. A vigorous shock shall not damage or disconnect parts of the skirt from the undercarriage or create pointed or sharp edges or corners.

The skirt may be completely or partly translucent or opaque, and its colour, reflection and shine shall not reduce the visibility of the ball for players, spectators or cameras. If there is an under-table light, the material of the skirt may efficiently contribute to dim or diffuse the light and reduce the halo on the floor around. Parts that may reflect the hall-light upwards shall be matted; white colour or bright shine at the table end is prohibited.

The skirt shall not carry advertisements or logos other than those authorised according to 3.2.5.7. The skirt shall not let cross balls to the space inside.

Skirts must get the agreement of the ITTF before they can be used; an authorisation scheme will be published on the ITTF website. A picture or drawing of the authorised skirt will be visible with the approved table on the related list at the ITTF website.



2.5.11. TABLES FOR YOUNG PLAYERS

Some tables are made so that the playing surface can be lowered by a small distance to accommodate younger players. It is strongly recommended that, for use in Asia, a 10 cm reduction be possible, and that for use elsewhere a 5 cm reduction is a reasonable compromise among the various heights currently available.

Height reduction may be by a continuous mechanism, with one or both of these heights clearly marked, or in discrete increments of 5 or 10 cm, or both. Provision for height adjustment in either manner will not be justification for relaxation of the requirement for rigidity during play.

2.5.12. TABLES FOR WHEELCHAIR PLAY

Tables that are suitable for wheelchair play must be of the same safety and playing quality standard as all other ITTF-approved tables. Therefore, stationary tables type (I) made of two separate tabletops or rollaway tables of construction type (II) cannot get ITTF-approval.

The area under the table end must observe the following requirements:

- There should be no projecting part that could hurt the player moving with his/her wheelchair under the table.
- The edges and the corners of the frame and all other parts that could be gripped or touched by the player should be blunt and smooth.

Additional dimensions of wheelchair table [mm]	
Distance of the end legs + cross bracing from the table end (l_3)	≥ 400
Free space below the end crossbar (h_3) and table end	≥ 480
Distance between the table end legs if $l_3 \leq 480$ mm	≥ 950
Height of the batten + playing board in the players safety area (h_6) (recommendation)	≤ 80

The brand of the table should mark through the table name that he has given the design not only a legal but also otherwise careful consideration for the needs of wheelchair players.

The ITTF Logo on the table frame can have a minimum size of 9 sqcm.

The ITTF recommends adding the logo "full accessibility for wheelchairs" (see figure 17) either on the frame or on the undercarriage, once per side, within an area of at least 9 25 sqcm and not more than 50 sqcm.



Figure 17: Wheelchair logo



2.5.13. SHOW-TABLES

Tables may be specially manufactured for a show-court use. They are usually not commercialised and can be considered as prototypes whose design is more attractive for the media and more appealing to spectators.

Such show tables must be of the same safety and playing quality standard as all other ITTF-approved tables. The brand must submit all documents proving that the tabletop of the table is exactly the same as for another ITTF approved table, that its fixation to the undercarriage does not change the bounce, and that the design and the structure of the undercarriage comply with all the safety requirements for the playing position.

It shall be possible to simply and quickly replace the tabletop:

- An accidental damage may not delay the competition (instructions, tools and a spare tabletop per tournament shall be available)
- Tabletops used shall be approximately of the same age than the other tabletops used at the tournament.

When knocked by the finger knuckles at different spots, the table surface of a show table should respond in nearly the same way than an ordinary table does. The sound should not vary considerably over the table surface and no substantial vibrations should spread from the table end or sides. When loaded the table surface should not bend down more as for normal tables.

The design of the undercarriage of such tables shall embellish the playing scene and may carry no permanent advertising on the undercarriage, and temporary advertising shall be according to the relevant ITTF regulations.

The ITTF must inspect the table before its use and may ask for improvements or require a test before approval can be given.



2.6. ADVERTISEMENTS/MARKINGS ON TABLE

REQUIREMENTS FOR TABLETOP-SIDE

Restrictions on advertising markings on tables are described below under "International Regulations" (6. Annex). The side of half a table is considered to be a "face", so that on the sides of the complete table the manufacturer's mark may appear twice.

- Each side of the table shall carry once the ITTF logo indicating that the table is ITTF-approved. The logo shall be visible in an area of at least 250 sqcm and not more than 50 sqcm that may be located on the frame of the tabletop or on the undercarriage.



Figure 18: ITTF logo

For more information, please refer to the ITTF Branding Guidelines. Both, the guidelines and the versions of the ITTF logo, can be requested from ITTF Equipment Department.

Permanent advertisements on tables are allowed only on the sides and ends of the tabletop and each shall be no longer than 60 cm on any face.

On each face, a continuous length of 70 cm shall be free, i.e. without any permanent marking including ITTF-logo, so that temporary advertisements can be affixed.

The organising authority of a competition may grant permission for additional, but not other table tennis equipment brand's, temporary advertisements, one on each half of a side and one on each end, clearly separated from the permanent advertisements.

REQUIREMENTS FOR TABLETOP-UNDERSIDE/UNDERCARRIAGE

The undercarriage can carry the ITTF-logo but shall not carry any permanent advertisement:

- on show tables the ITTF logo may be bigger on the undercarriage.

Country of origin markings: A printing or sticker (letters at least 1 cm high) on the tabletop underside shall inform as follows:

- if the undercarriage and the tabletop are made and assembled in the same country, simply print: «Made in <Country>»
- if the essential parts are made or assembled in different countries, print (all together not one of the three):
 - o «tabletop made in <country 1>»
 - o «table undercarriage made in <country 2>»
 - o «table assembled in <country 3>»
- If tabletop and undercarriage are made and assembled in the same <country 1>, the tabletop frame may wear on both (out)sides once «made in <country 1>».

Warning sticker: Warnings and notice for use should be applied permanently to the undersides of both tabletops, at eye height. The information shall be provided in form of drawings or pictures. Additional headings or advice must be written in easily legible letters in the language of the user's home country.

Manufacturer stamp: Tabletops (I, II) or tables (III, IV) must carry on its underside a rectangular not-detachable label or permanent-ink stamp of minimum 18 sqcm informing about the month/year of production (pitch min. 16 pts), of the top designed as follows (see figure 19):

TABLE TOP SURFACE	
Month / Year PRODUCTION	10 / 13
<i>(Manufacturer's internal notices or codes)</i>	

Figure 19: Manufacturer stamp

Operating instructions: Written operating instructions must describe the regular handling and the precautions that should be taken during the setting up of the table in the playing or in the storage position and when it is rolled away;

- the maintenance instructions must include the warning to re-place any broken or damaged part immediately and
- should give instructions about cleaning of the tabletop.
- the folder(s) must give a contact address where the customer can get in touch with the manufacturer or the brand.

All information should comply with international and local legislation: this is the responsibility of both the manufacturer and the local distributor.

- minimum information on all tabletop undersides shall be pictograms about: Children shall not play on or near the table in storage position; Moving the table on a sloping surface may be dangerous; During the unfolding and folding of the table, the user has to observe a sequence of steps and precautions.
- a table whose weight excessively loads the arms of one single person requires an additional warning: Folding and unfolding requires two persons!
- an arrow may indicate the location of a safety catch that must be unlocked manually.

ADDITIONAL REQUIREMENTS FOR THE TABLE

Assembly instructions: A folder coming with the packaging should provide written instructions in English and at least in the language where the table is to be delivered. The assembly instructions must include:

- a list that allows easily identifying the loose parts and the tools required;
- drawings or pictures of the steps and explanations for the assembly of the parts;
- warnings about the precautions that need to be taken during assembly of the table including the stages where more than one adult is needed;
- advice about not over-tightening screws at moving parts and
- how to carefully test the functionality immediately after completing the setting up



TESTING





3. TESTING-PROTOCOL

3.1. TESTING PROCEDURE

PREPARATION FOR TESTING LABS

The brand or manufacturer has to send a complete table with assembly instructions to one of the two testing labs. They can choose between Germany and China.

SEQUENCE OF TESTING

1. Table specifications
 - a. Eyesight inspection
 - b. Tactile inspection
 - c. Markings/advertisements
 - d. Table dimensions
 - e. Lightness and Gloss of tabletop
 - f. Finish of surface
 - g. Locking devices (in playing and storage position)
2. Tabletop
 - a. Flatness
 - b. Friction
 - c. Ball Bounce and Regularity
3. Endurance (in playing and storage position)
 - a. Rigidity
 - b. Stability
 - c. Loading capacity
4. Report (in ITTF Approval Forms)

Two to three weeks after testing and receiving the results, the table is disposed of by the laboratory unless the brand has other plans for the table.

PREPARATION FOR ITTF EQUIPMENT OFFICE

The brand or manufacturer has to send the following sample size to the Equipment Office (for Ball Bounce on Table (BBOT) testing):

- 40 x 60 cm sample of tabletop with underside information about brand name, table name, manufacturer name, year of manufacturing and an arrow that shows the playing direction



3.1.1. COLOUR/GLOSS

The colour and gloss of the tabletop are measured with devices following the 60° specular gloss, ASTM procedure D 523.

3.1.2. FLATNESS

Test material: Directional batten, caliper gauge

To qualify for approval, the playing surface must not be warped.

A rigid straight-edged surveyor's staff about 2 m long is placed on 2 shims of identical height that rest on 2 diagonally opposed corners of the playing surface of a tabletop: the difference between the smallest and the largest gap between the playing surface and the staff shall not exceed 3.0 mm. Regardless of this criterion, however, no warping will be acceptable that is visible to the naked eye.

One means of reducing warping is to increase the thickness of the playing board, but the complete elimination of warping in this way probably requires an uneconomical thickness. A common compromise is to use at least the minimum thickness that gives the desired bounce (for tournament tables it currently varies from 18 to 30 mm) and to reinforce the underside of the top by battens around the edge, or recessed under the table, or both.

3.1.3. FRICTION

Test Material: Ball Bounce on Table device by Wassing, tabletop sample from the applied table (size approx. 40 cm x 60 cm), DHS DJ40+*** balls



Figure 20: BBOT Device

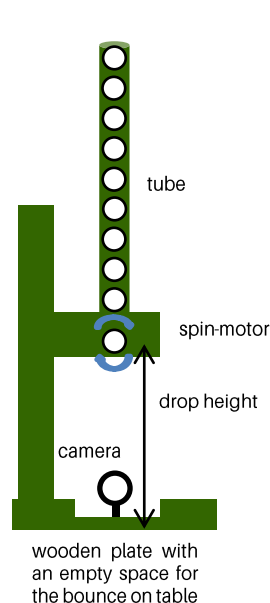

Figure 21: BBOT Description

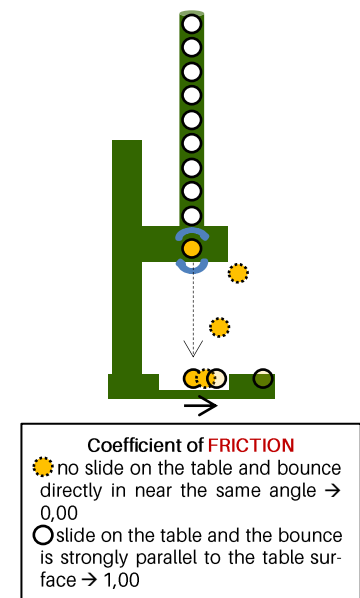

Figure 22: BBOT- Friction



20 balls will be tested on the sample board of the tabletop (of the same colour) with the BBoT testing device (see figure 20), which will measure with cameras the restitution and friction of a ball-table-combination (see figure 21). The device is first set at a height of 180 mm, rotating the ball with 67 hz (top-spin), before let the ball fall through the tube and spin motor on the table surface.

The higher the friction value is, the more the ball will bounce forward (see figure 22). All 20 ball measurements on the tabletop sample will be calculated to an average result.

This average result of the coefficient of friction (CoF) must be between 0.150 and 0.350 and will be called as the reference value for any future testing/re-testing of this tabletop.

Once the result detected is within the limit, the tabletop will be categorized into one of the friction range (FR) groups and published on the equipment website.

TOLERANCES

To check the quality of the surface, regular re-tests (5-year cycle) and market/retail testing are carried out. Manufacturers are permitted to deviate from the specified reference value. Even when the newly measured value is out of the FR this tabletop has been categorized, it will be accepted and the former FR will stay, as long as the newly measured value is within the tolerances below:

Tolerances for CoF in re-testing or retail testing	
01.06.2025 - 31.12.2029	+ 0,035
01.01.2030 - 31.12.2034	+ 0,030
01.01.2035 - open end	+ 0,025

3.1.4. BOUNCE/RESTITUTION

Test material: ball, bounce-framework, 300 mm spacer bar, measuring tape, software: "audacity"

Both speed and spin of a ball are affected by the resilience and the friction properties of the playing surface and other factors that all together govern the bounce.

The vertical bounce of a spin-less ball is measured by dropping an approved ball of average bounce on to the table; from a height of 300 mm, measured between the playing surface and the bottom of the ball, the ball must rebound to a height of 230-260 mm. A table will not be approved unless the bounce is legal and uniform (see below) over the entire playing surface.

Almost any tabletop constructed as described above (i.e. with at least 25 mm plywood or 18 mm particle-board) will give a suitable bounce. It is this bounce, rather than the material of construction, that is of paramount importance.

TOLERANCES

Tolerances on a table (= 2 tabletops)	
Bounces outside the limits of the mean bounce (230 - 260 mm)	0
Difference of the mean bounce of the 2 tabletops [mm]	≤ 1



Tolerances on each tabletop	
Number of average bounces more than 2.0 mm higher or lower than the mean bounce	≤ 2 average bounces
Difference of any average bounce at a special point to the mean bounce [mm]	≤ 4
Difference between maximum and minimum average bounce [mm]	≤ 5

MEASUREMENT METHODS

There are several possible methods for the measurement of the height of the bounce:

- By eye, but the operation is quite tiring, and it is subject to both random and systematic errors.
- A simple and precise method involves the formula $h=gt^2/8$, where h is the bounce height in m, g is the acceleration due to gravity in m/sec^2 , and t is the time in seconds for the complete bounce, up and down. The time t is measured electronically; a timer is started by a microphone detecting the first bounce, and is stopped similarly by the second bounce.
- By video-taping or photographing the vertex of the bounce: the camera is adjusted at the bounce summit and a scale in the background located next to the ball indicates the height. The bounce height then is determined either by the operator using a slow motion (picture by picture) procedure or by a computer calculating the exact vertex of the bounce.
- By electronic measurement before the bounce summit of the time that a ball needs to interrupt successively two light beams. The geometric mean of the measures permits calculation of the maximum bounce height.

EXECUTION

The ball should always be dropped without spin on the same spot of its surface in order to eliminate the variation due to ball structure; each measure should be tripled.

In order to investigate whether a table half has a uniform bounce, triplicate assessments of the bounce are made for each tabletop at 16 prefixed points and 3 special points such as above the legs. If one or more of the prefixed 16 points are located over fixations, they may be slightly displaced.

Using a computer program the observed bounce values can be converted into a three-dimensional plot from which the calculated uniformity can be instantly visualised.

For the calculation of the bounce uniformity, several conditions and mathematical steps have to be considered. The location of the regular and special points is given in the coordinate system [0-137] × [0-152] cm describing the whole surface of a table half with an X-Y axis system, where X refers to the table-side and Y to the table end. The figure 23 indicates the 16 regular points.

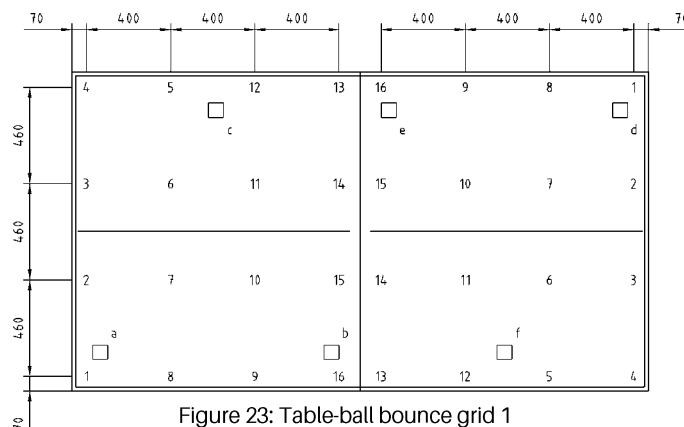

Figure 23: Table-ball bounce grid 1



The median value of the bounce values (= average bounce) per point is used for further analysis. The median is defined as the middle observation. To assess uniformity for the whole surface, the bounce is modelled as a function of the x- and y-ordinates. This function is estimated with the available information at the 16 positions; then for the whole surface a predicted bounce value is obtained which can be 3-D-plotted and/or summarised per half.

Having 4 values per ordinate, a cubic equation can be fitted. Thus, for the bounce function the following general expression is taken:

- bounce $(x,y) = \sum_i \sum_j \alpha_{ij} x^i \cdot y^j$, where i and j range from 0 to 3 and \sum denotes the summation symbol over the index. The 16 coefficients alpha sub ij are estimated by solving the system with 16 linear equations from the 16 known assessments of the table half (it is advised to use statistical software for multiple regression). With this approach, the bounce function value on a grid position equals the reported value. From the known bounce function, the predicted bounce value is computed for arbitrary interpolative positions (x,y) . From the span of the used grid, a high-density interpolation grid has been defined with step size 1 mm alongside the X- and Y-axis, and for all these points, the predicted bounce is computed. From these bounces, the minimum, maximum, mean and range for the interpolated surface are computed and a 3-D plot may visualise the behaviour of the surface in regard of bounce uniformity. The following specifications should be met for the bounce uniformity:
 - The range of the predicted bounce values should be less than 10.0 mm. At the special points, the maximum value should be less than 3.0 mm higher than the maximum value given by the interpolated points. The difference between the mean predicted bounces for the two table halves should be less than 2.0 mm.

A less scientific evaluation for the quality of the bounce regularity is acceptable. At each point the average bounce is calculated out of the three measurements and rounded up to the next full or half millimetre-unit; if one of the three measurements is really outlying, it may not be considered or the bounce may be repeated. The medium bounce of a tabletop is calculated through the average bounces at the 9 points prefixed according to the figure 24 and 3 special points located over legs, fixations or parts of the inner frame. If one or more of the 9 points are located over fixations etc., they may be slightly displaced.

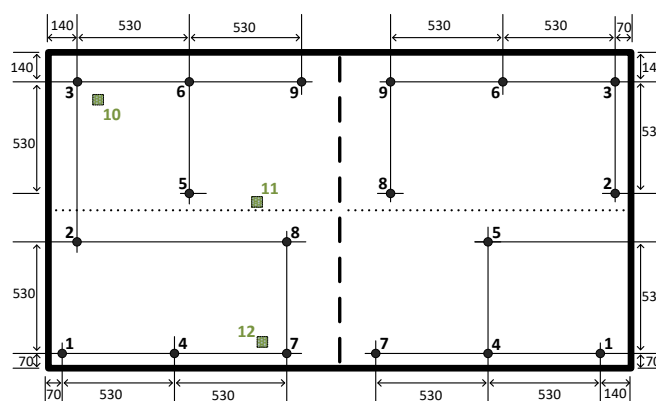

Figure 24: Table-ball bounce grid 2



3.1.5. ENDURANCE TESTS

Test material: holding bar, load cell, measuring tape, weight discs up to 80 kg, grid, stopwatch, counter device

RIGIDITY

The rigidity of a table expresses its resistance to the shift of its top when pulled by a force of 300 N in the longitudinal (figure 25) and 200 N in the transversal direction (figure 26).

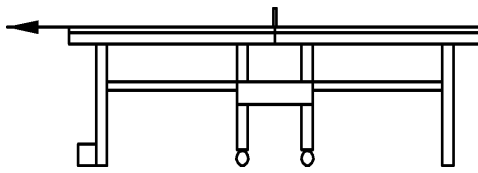

Figure 25: Longitudinal direction pulling

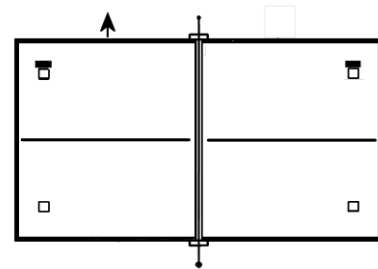

Figure 26: Transversal direction pulling

This traction is applied to the middle of the end and to the middle of the half side of a table ready to use with a mounted net and with both end-feet blocked by a 50 mm high obstacle on the floor. The shift of the tabletop in the longitudinal or in the transversal direction should be less than 10 mm. If a permanent net without clamps is attached to the table, the same rigidity shall be reached.

STABILITY

The stability expresses the strength and the resistance to deformation or/and collapse of the undercarriage under a pushing shock of 300 N in longitudinal direction on the full tabletop (figure 27) or of 200 N in the transversal direction on the table in playback position or on an isolated tabletop (figure 28). No permanent deformation and no unbalance should appear, and no part shall disconnect. The desired rigidity and stability can be achieved through a strong, heavy or other specially designed structure and through safety catches and/or wheel brakes.

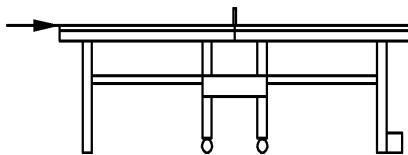

Figure 27: Longitudinal direction pushing

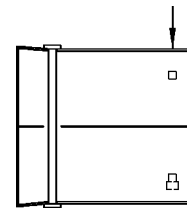

Figure 28: Transversal direction pushing

LOADING CAPACITY

The loading capacity of a table or tabletop expresses its resistance to tilting, folding or deforming when its most unfavourable spots, i.e. table end corners and net end corners are loaded with a weight of 80 kg, which shall be a disc of 30 to 35 cm diameter and whose gravity centre is applied at the interior corner of a square of 15 cm side length. The table should not show any unstable tendency during this test and not sustain any damage. The corners of the table should not considerably bend down under the load of 80 kg. During this test no net is mounted.



If a permanent net without clamps is attached to the table, the same rigidity and loading capacity shall be achieved.

LOCKING DEVICES

The locking systems must resist and not deform, when a horizontal pulling force of 200 N is applied at the top (the end) tending to unfold the raised tabletop without unlocking it. For this test the undercarriage shall be strongly fixed to the floor. After the test, the state of the locking devices is checked. The ITTF recommends that the locking devices should sustain without damage the endurance test as described in section "Movements" below.

A rollaway table-unit, in its most unfavourable position, must not tip over nor roll on a surface sloping at 10 degrees. The track between the wheels must be wide enough to give the desired stability; at least 2 brake-wheels per table unit are recommended.

MOVEMENTS

The table, in its storage position, is submitted to a test of 250 to-and-fro movements over 5 m, i.e. 2500 m with a speed of 2 km/h created by unguided pulling.

The rolling circuit (figure 29 and 30) is made up and adapted to each table. Three groups of identical obstacles, constructed in wire mesh form with eight steel wires (diameter 3.7 mm) 50 mm apart, are placed over an area 7 m long to 1,5 m wide. The distance between the first group of obstacles and the second group is equal to the width of the table (transverse distance between the axes of the wheels); the distance between the second group of obstacles and the third group is equal to the table width plus 25 mm.

This layout permits the application of stress simultaneously then alternately on the chassis as a whole and on the wheels in particular.

No locking device (except the one acting on gravity) shall unlock itself, even temporarily, or be deformed in a way that it does not function correctly after the test. The rolling devices should work properly after the test. Fixings, hinges and joints should not be damaged. A visual inspection will check all the items and detect malfunctions or possible risks.

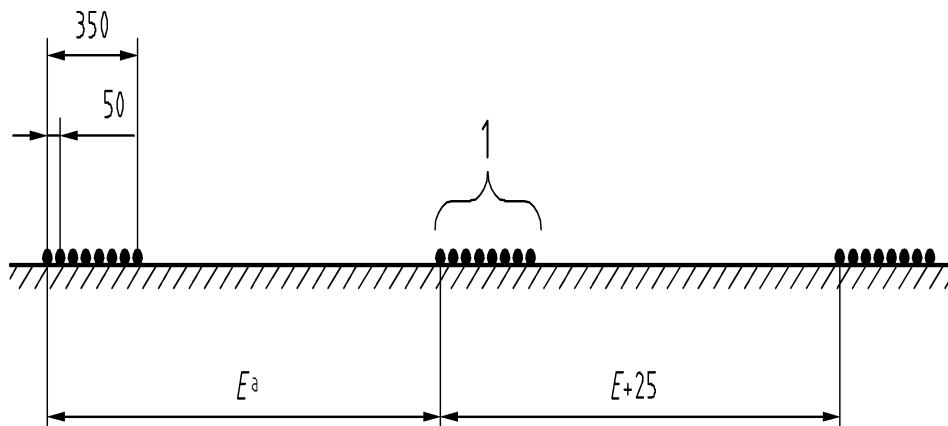

Figure 29: Group of obstacles (8 steel wires, diameter 3.7 mm)
[E = distance between 2 wheels (transverse direction of the table)]

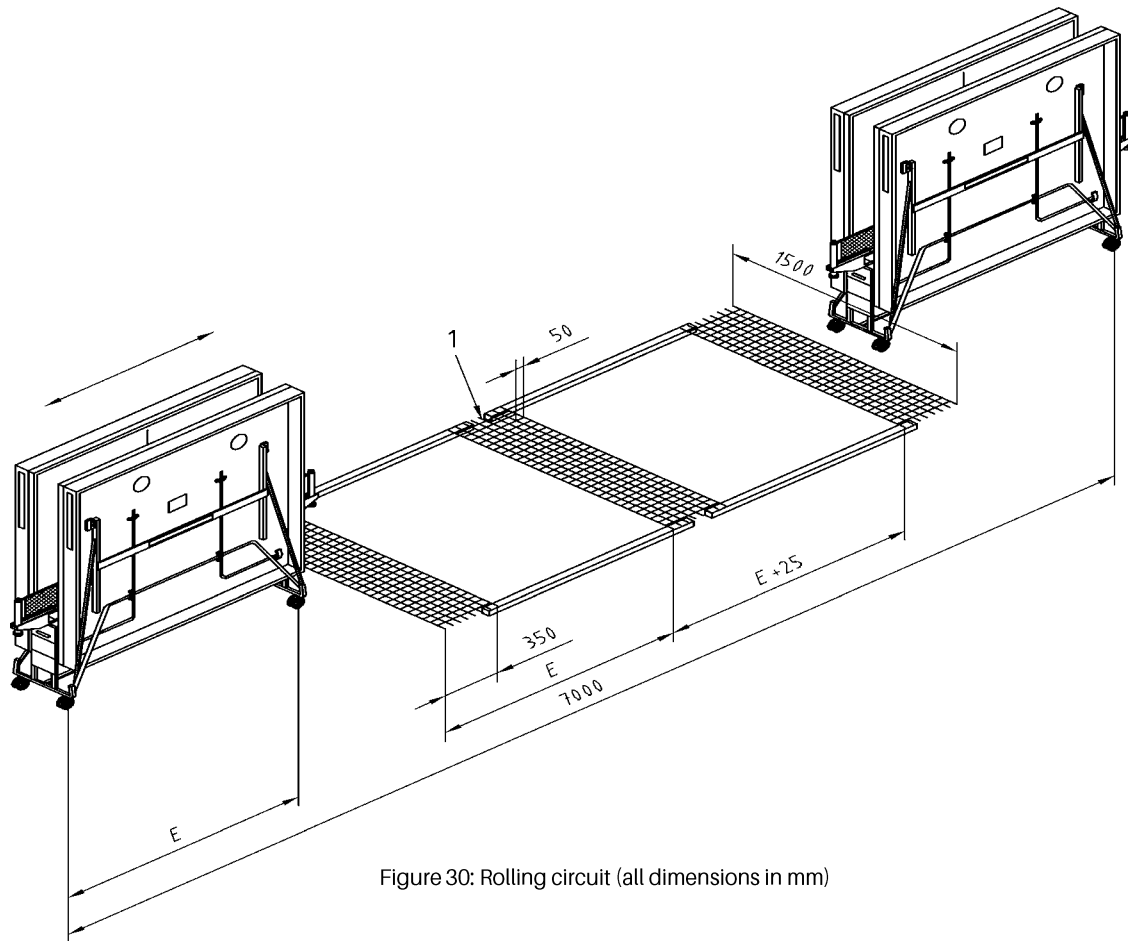

Figure 30: Rolling circuit (all dimensions in mm)



3.2. TESTING LAB

TÜV THÜRINGEN ANLAGENTECHNIK GMBH & CO. KG

Prüfstelle für Gerätesicherheit
Testing Centre for Equipment Safety
Ichtenshäuser Straße 32
99310 Arnstadt
Germany

SHANGHAI INSTITUTE OF STATIONERY AND SPORTING GOODS LTD. COMPANY

ITTF Table Tennis Inspecting Laboratory,
2735 Bao An Road,
JiaDing District, SHANGHAI 201800, P.R. China

3.3. SERVICES

Any brand bearing an approval of one or more products is invited to seek further explanations to the results of testing, to matters of calculation, statistical evaluation or – as far as confidentiality is not affected – general benchmarks from the ITTF tables testing results database. Such service is included in the approval fee.

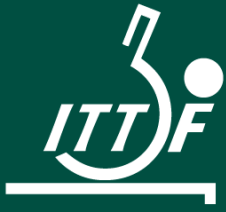

APPROVAL





4. APPROVAL - REQUIREMENTS

The following document is a guide how to announce a table tennis table for ITTF approval. This requires the table to bear our standards for an ITTF APPROVED table.

The ITTF Quality Program for tables was developed with the aim of improving the quality of competition tables produced and used throughout the world.



4.1 GET APPROVED

NEW BRAND REGISTRATION

A new brand, who wishes to enter in relationship with the ITTF and before the approval procedure can be started, needs to

- apply for registration by completing the online-form "Table Approval Form"

The ITTF reserves its right not to accept a company as a brand, for table tennis goods.

The ITTF cannot be held responsible for wrong or misleading information, or for names illicitly used by the brands.

OFFENSIVE TRADEMARKS/BRANDS

It is at the ITTF's own discretion to refuse a brand the possibility to join or continue being part of the ITTF Equipment Approval Scheme, in case of use of logos or advertising that would be considered offensive or adverse to ITTF policies.

BRANDS UNDER PLAYERS' NAMES

In case of an application by a company using a top level player's name or part of his/her name as brand name, the ITTF at its own discretion can ask the company to provide a written confirmation by the player before processing the application.

BRANDS WHO PREVIOUSLY USED THE ITTF TRADEMARK ILLEGALLY

The ITTF can refuse the application from companies who previously used the ITTF trademark for non-approved equipment under the same or different brand name on the application. The ITTF can further refuse the application from a brand who may have obtained the rights from the previous brand, who illegally used the ITTF trademark for non-approved equipment.

APPROVAL SCHEME - NORMAL PROCEDURE

Please see the application process for the company and the table tests below. Note that each step must be completed before the next one can be started.

In tables there are four different types of application:

1. TABLE - NEW
 - ➔ New table name, tabletop and undercarriage made or assembled from new manufacturer
2. TABLE - MODIFICATION of own approved table
 - ➔ Modification of the own table (table is already ITTF approved)
3. TABLE - MODIFICATION of another approved table
 - ➔ New table based on the modification of an already approved table
4. TABLE - SHOWTABLE



TABLE - NEW





STEP 1  DOCUMENTS	Applicants	Provide the following documents by email to the ITTF Equipment: <ul style="list-style-type: none"> The table form with application and dimensions: <ul style="list-style-type: none"> sheets should be filled in and signed (one EXCEL and one signed PDF) All annexes mentioned in the end of the "Dimensions" sheet of the approval form
	ITTF	After the above-mentioned documents are received, ITTF will send an email confirming all documents are correct or something is still missing or needs to be modified.
STEP 2  TABLE TEST	Applicants	Please send the following samples: <ul style="list-style-type: none"> One full table to the testing lab One sample of 40cm x 60cm to the ITTF Equipment Office: <ul style="list-style-type: none"> Write on the underside name of brand, manufacturer and product Year of production Give an arrow for the playing direction
	ITTF	ITTF will send an email informing about the test order, required sample sizes and include an invoice for the table test.
STEP 3  LICENSE AGREEMENT	Applicants	Please transfer the requested amount according to the received invoice.
	ITTF	Once the testing fee has been paid the ITTF will inform about the test results. If the table has passed all official tests, the applicants can request the time they want the approval of their tables to become effective. The ITTF will send the invoice of the approval fee for the current year.
STEP 4  PAYMENT	Applicants	Please transfer the requested amount according to the received invoice.
	ITTF	The ITTF will confirm receipt of the invoice amount.
STEP 5  APPROVAL	Applicants	Please inform the ITTF when they should publish the approved product on the ITTF equipment website.
	ITTF	The product is now ITTF approved and online on the ITTF list of approved tables.



TABLE - MODIFICATION OF OWN APPROVED TABLE

Modification of an already approved table under the same name, brand and manufacturer





STEP 1  DOCUMENTS	Applicants	Provide the following documents by email to the ITTF Equipment: <ul style="list-style-type: none"> The table form with application, dimensions and confirmation of sameness <ul style="list-style-type: none"> sheets should be filled in and signed from the brand and manufacturer (one EXCEL and one signed PDF) All annexes mentioned in the end of the "Dimensions" sheet of the approval form
	ITTF	After the above-mentioned documents are received, ITTF will send an email confirming all documents are correct or something is still missing or needs to be modified.
STEP 2  TABLE TEST	Applicants	Necessity of full table testing depends on the modification Necessity of 40cm x 60cm sample to the ITTF Equipment Office if tabletop was modified: <ul style="list-style-type: none"> Write on the underside name of brand, manufacturer and product Year of production Give an arrow for the playing direction
	ITTF (if testing is needed)	ITTF will send an email informing about the test order, required sample sizes and include an invoice for the table test.
STEP 3  LICENSE AGREEMENT	Applicants	Please transfer the requested amount according to the received invoice.
	ITTF (if testing is needed)	Once the testing fee has been paid the ITTF will inform about the test results. If the table has passed all official tests, the applicants can request the time they want the approval of their tables to become effective. The ITTF will send the invoice of the approval fee for the current year.
STEP 4  PAYMENT	Applicants	Please transfer the requested amount according to the received invoice.
	ITTF	The ITTF will confirm receipt of the invoice amount.
STEP 5  APPROVAL	Applicants	Please inform the ITTF when they should publish the approved product on the ITTF equipment website.
	ITTF	The product is now ITTF approved and online on the ITTF list of approved tables.



TABLE - MODIFICATION OF ANOTHER APPROVED TABLE

New table based on the modification of an already approved table











STEP 1  DOCUMENTS	Applicants	Provide the following documents by email to the ITTF Equipment: <ul style="list-style-type: none"> The table form with application, dimensions and confirmation of sameness <ul style="list-style-type: none"> sheets should be filled in and signed from the brand and manufacturer (one EXCEL and one signed PDF) All annexes mentioned in the end of the "Dimensions" sheet of the approval form
	ITTF	After the above-mentioned documents are received, ITTF will send an email confirming all documents are correct or something is still missing or needs to be modified.
STEP 2  TABLE TEST	Applicants	Necessity of full table testing depends on the modification Necessity of 40cm x 60cm sample to the ITTF Equipment Office if tabletop was modified: <ul style="list-style-type: none"> Write on the underside name of brand, manufacturer and product Year of production Give an arrow for the playing direction
	ITTF (if testing is needed)	ITTF will send an email informing about the test order, required sample sizes and include an invoice for the table test.
STEP 3  LICENSE AGREEMENT	Applicants	Please transfer the requested amount according to the received invoice.
	ITTF (if testing is needed)	Once the testing fee has been paid the ITTF will inform about the test results. If the table has passed all official tests, the applicants can request the time they want the approval of their tables to become effective. The ITTF will send the invoice of the approval fee for the current year.
STEP 4  PAYMENT	Applicants	Please transfer the requested amount according to the received invoice.
	ITTF	The ITTF will confirm receipt of the invoice amount.
STEP 5  APPROVAL	Applicants	Please inform the ITTF when they should publish the approved product on the ITTF equipment website.
	ITTF	The product is now ITTF approved and online on the ITTF list of approved tables.



TABLE - SHOWTABLE

STEP 1  DOCUMENTS	Applicants	Provide the following documents by email to the ITTF Equipment: <ul style="list-style-type: none"> The table form with application, dimensions and confirmation of sameness <ul style="list-style-type: none"> sheets should be filled in and signed from the brand and manufacturer (one EXCEL and one signed PDF) All annexes mentioned in the end of the "Dimensions" sheet of the approval form
	ITTF	After the above-mentioned documents are received, ITTF will send an email confirming all documents are correct or something is still missing or needs to be modified.
STEP 2  TABLE TEST	Applicants	Necessity of full table testing depends on the modification Necessity of 40cm x 60cm sample to the ITTF Equipment Office if tabletop was modified: <ul style="list-style-type: none"> Write on the underside name of brand, manufacturer and product Year of production Give an arrow for the playing direction
	ITTF (if testing is needed)	ITTF will send an email informing about the test order, required sample sizes and include an invoice for the table test.
STEP 3  LICENSE AGREEMENT	Applicants	Please transfer the requested amount according to the received invoice.
	ITTF (if testing is needed)	Once the testing fee has been paid the ITTF will inform about the test results. If the table has passed all official tests, the applicants can request the time they want the approval of their tables to become effective. The ITTF will send the invoice of the approval fee for the current year.
STEP 4  PAYMENT	Applicants	Please transfer the requested amount according to the received invoice.
	ITTF	The ITTF will confirm receipt of the invoice amount.
STEP 5  APPROVAL	Applicants	Please inform the ITTF when they should publish the approved product on the ITTF equipment website.
	ITTF	The product is now ITTF approved and online on the ITTF list of approved tables.



4.2. STAY APPROVED

If we do not get any message that one of your products should be withdrawn, we will send you at the end of the year a mail to confirm that all products should stay approved. Afterward we will send the invoice about the approval fee for the coming year. After we received your payment all products will stay on our lists.

RE-TESTING OF TABLES

In case of concerns about the structure and quality of a specific table, the ITTF can order a re-test of the table at the brands costs: if the table does not respond to the expectations of M1, the table will be withdrawn from the list of ITTF approved tables. Approval-fees already paid will not be reimbursed.

Periodic re-testing of approved tables can be organized by the ITTF on the brands costs in order to make sure that all requirements of M1 are observed, that changes of M1 have been correctly applied to all tables and that substantial changes at individual tables have been authorised by the ITTF before their implementation.

RE-TESTING OF TABLETOPS

Every 5 years, ITTF will collect the sample board from the brands/market and test the CoF of the tabletop.

VOLUNTARY TABLETOP TESTING

Every manufacturer or brand can use the ITTF BBoT device for research testing. Therefore, a request at first and a sample afterwards has to be sent to the ITTF. A testing fee will be charged.

4.3. CHANGES

Any change of the brand or the table name, tabletop, undercarriage, locking devices and any other changes relevant for ITTF approval must be notified to the ITTF. The changes must be confirmed by the ITTF in writing.

The failure to announce changes to the ITTF will be penalized with a fine or can even lead to an end of the ITTF approval in cases of severe or repeated failures. It is the company's responsibility to inform the ITTF, in case they have changes in contact details, such as e-mail addresses, contact persons, postal address etc.

BRAND OWNERSHIP

If a company takes over the brand name from another company, who owes money to the ITTF, the equipment will remain approved only if the new owner submits a letter of confirmation, signed by the old and new owner, ensuring that all the rights and debts towards ITTF of the brand were transferred to the new owner. The ITTF will inform the new owner about delinquent payments, if any, which should be settled. Otherwise, the equipment will be removed from the ITTF Lists.



4.4. WITHDRAW APPROVAL

If the approval of one of your products shall be withdrawn, please send us a corresponding mail. The cancellation period is 3 years. After confirming your cancellation, the product will be marked with the expiring date, which means 3 years from the confirmation date on.

4.5. RE-INTEGRATION OF TABLES

A table withdrawn from the ITTF-list can re-gain approval: the ITTF decides if no test, a partial test or a full re-test is necessary.

If the withdrawal happened more than 24 months ago, a full testing is compulsory. In case a brand wishes to renew the approval in between 24 months after withdrawal, he must pay the full approval-fee for the last 2 years.

4.6. FEES

Please contact us to get the valid fee list.

TESTING

On behalf of your order to approve a table we will charge a testing fee to you after we received your samples. This testing fee must be paid independently from the result of the testing.

If a table does not pass the testing, it is your choice to stop the approval process, or send new samples. In this case we will charge the second testing like the first one, under the same conditions.

FIRST APPROVAL

After your table has passed the testing, we will charge an approval fee for the rest of the year.

YEARLY APPROVAL

In order to be able to keep the products on the list of ITTF Approved tables, the brand must pay the yearly approval fees for the first table, 2nd table, further tables and additional colours. ITTF will send an invoice at the end of the year, valid for the approval of the coming year. Payment receipt must be before the new year started to keep the products on our lists.

CANCELLATION PERIOD

The cancellation period for tables is 3 years. 50 % withdrawal fee will be charged for this period.



CERTIFICATE

For all of your approved tables you will get a yearly valid certificate.

4.7. PENALTIES

The ITTF can fine, suspend or delete brands from its directory and suspend or delete their products from its lists in case of infringements or situations affecting negatively the table tennis game or the reputation of the ITTF or if they commercialize substances or products banned by the ITTF, after taking into account written explanations of the company about the problem.

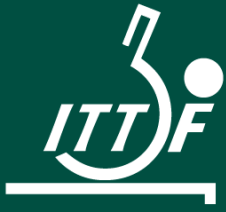

EXPLORE





5. EXPLORE-LIST

5.1. ITTF APPROVED TABLES

Under <https://equipment.ittf.com/#/equipment/tables> you can find all currently approved tables in our data base.

New products and withdrawn ones are marked accordingly.



ANNEX

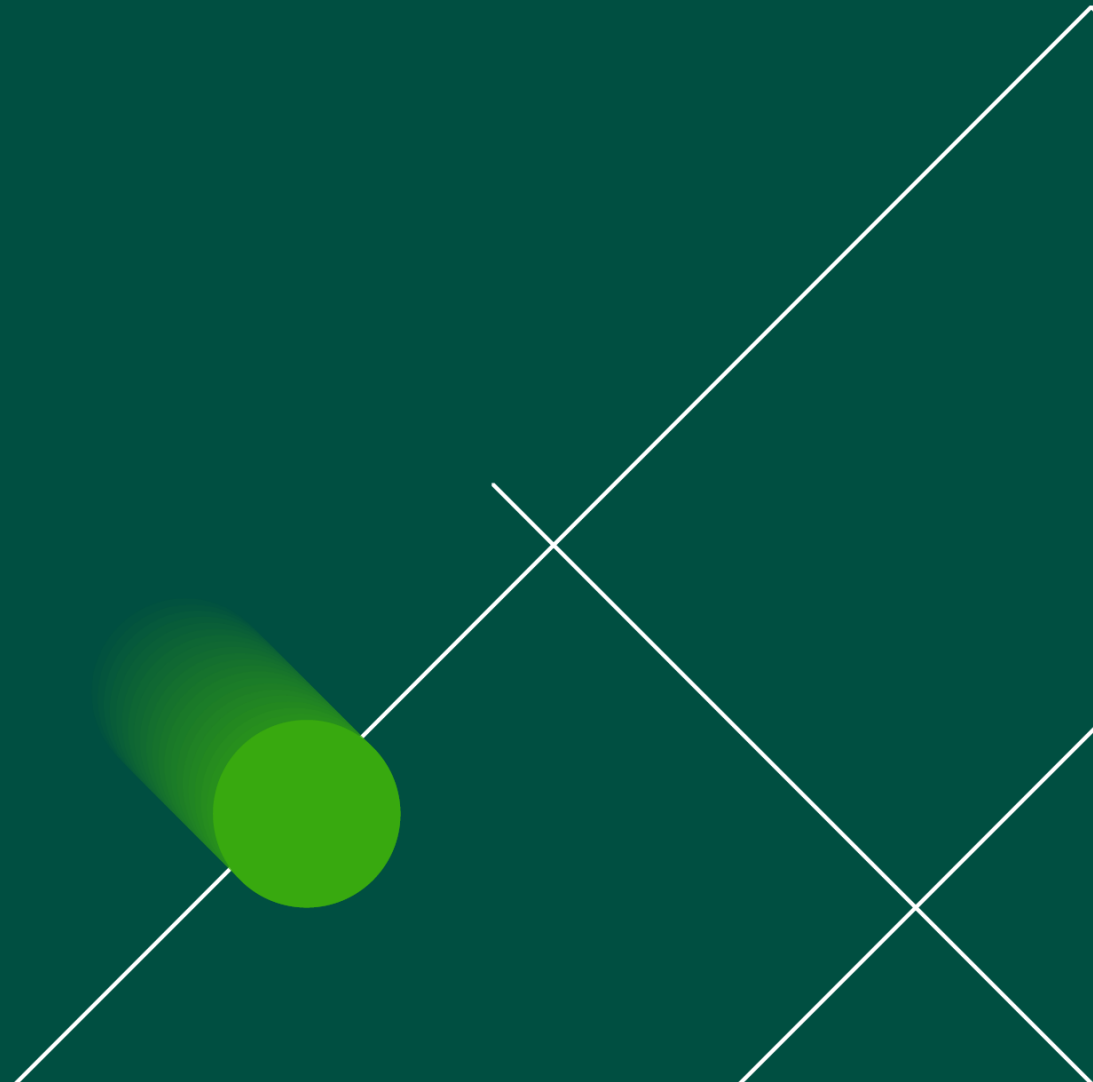



6. ANNEX

6.1. TERMS OF REFERENCE

The Laws of Table Tennis relating to the table are as follows:

- 2.1 The Table
 - 2.1.1 The upper surface of the table, known as the playing surface, shall be rectangular, 2.74 m long and 1.525 m wide, and shall lie in a horizontal plane 76 cm above the floor.
 - 2.1.2 The playing surface shall not include the vertical sides of the tabletop.
 - 2.1.3 The playing surface may be of any material and shall yield a uniform bounce of about 23 cm when a standard ball is dropped on to it from a height of 30 cm.
 - 2.1.4 The playing surface shall be uniformly dark coloured and matt, but with a white side line, 2 cm wide, along each 2.74 m edge and a white end line, 2 cm wide, along each 1.525 m edge.
 - 2.1.5 The playing surface shall be divided into 2 equal courts by a vertical net running parallel with the end lines, and shall be continuous over the whole area of each court.
 - 2.1.6 For doubles, each court shall be divided into 2 equal half-courts by a white centre line, 3 mm wide, running parallel with the side lines; the centre line shall be regarded as part of the each right half-court.

The Regulations for international competitions (3.2.1.2) state as follows:

- 3.2.1.1 The approval and authorisation of playing equipment shall be conducted on behalf of the ITTF Council by the Equipment Committee; an approval or authorisation may be suspended by the Executive Board at any time and subsequently the approval or authorisation may be withdrawn by the ITTF Council.
- 3.2.1.2 ... the equipment ... shall be selected from brands and types currently approved by the ITTF.
- 3.2.5.3 ...fluorescent, luminescent or glossy colours shall not be used anywhere in the playing area...
- 3.2.5.6 Advertisements on the table shall comply with the following requirements:
 - 3.2.5.6.1 There may be 1 permanent advertisement of the manufacturer's or supplier's name or logo on each half of each side of the table top and on each end.
 - 3.2.5.6.2 There may be 1 temporary advertisement, which also can be of the manufacturer's or supplier's name or logo, on each half of each side of the table top and on each end.
 - 3.2.5.6.3 Each permanent and each temporary advertisement shall be contained within a total length of 60cm.
 - 3.2.5.6.4 Temporary advertisements shall be clearly separated from any permanent advertisements.



- 3.2.5.6.5 Advertisements shall not be for other table tennis equipment suppliers.
- 3.2.5.6.6 There shall be no advertisement, name of table, name or logo of the manufacturer or supplier of the table on the undercarriage, except if the table manufacturer or supplier is the title sponsor of the tournament.
- 3.2.5.7 There may be 2 temporary advertisements on nets on each side of the table which shall be clearly different from the colour of the ball in use, shall not be within 3cm of the tape along the top edge; advertisements placed on parts of the net within the vertical extensions of the side lines of the table shall be a logo, wordmark or other icons.

6.2. DEFINITIONS OF TERMS AS USED IN THIS DOCUMENT

Approval	The certification for conformance to the technical standards as set by the ITTF, for shared playing equipment like balls, nets, sports floors and tables.
ITTF Lists	Lists of ITTF Approved Equipment
Manufacturers	Companies producing equipment
Distributors	Companies not owning ITTF Approved Equipment under their own brand name, but selling one or more brands of ITTF Approved Equipment.
Companies	Official companies who have a registered brand
Brand	Registered brand
Product	Particular name used to describe a specific product of a brand.
Testing	The series of tests and measurements required to verify quality, safety and compliance with ITTF requirements in order to get approval by the ITTF.
Initial testing	The very first testing required for new non-approved equipment, before approval may be granted.
Re-testing	Any repeated testing either because of a prior failed test, of a periodically scheduled quality inspection, or of a problem with a specific model.
Full testing	Full testing includes all tests and measurements defined in the manuals.
Partial testing	selects the tests and measurements needed for the purpose of the testing.
Quality	All regulations and measures targeting to provide customers and users with the assurance best-quality equipment, manufactured in full respect of ITTF technical and safety standards and marketed/labelled in a complete, non-misleading way.
Final Approval	The equipment item fulfils all ITTF requirements.



Provisional	The equipment fulfils the ITTF requirements, but needs to proof at an ITTF tournament that it fully meets the specifications and expectations before approval becomes final. Provisional approvals may be subject to conditions.
Withdrawal	Approval discontinued, when requested by the brands.
Suspension	Approval provisionally or temporarily discontinued, when decided by the ITTF.
Deletion	Approval permanently discontinued, when decided by the ITTF.
Infringement	Any action of violation of the ITTF policies, laws and regulations.
Sanction	Warnings and penalties imposed by the ITTF to brands in case of infringements.

End of M1



ITTF QUALITY PROGRAMME

FOR NET GAUGES -
MANUAL



January 2026



1. THE ITTF QUALITY PROGRAM FOR NET GAUGES
 - 1.1 INTRODUCTION
 - 1.2 ITTF LOGO & TRADEMARK
 - 1.3 CONTACT

2. STANDARDS TO ACHIEVE
 - 2.1 PRODUCT & BRAND
 - 2.2 MANUFACTURING
 - 2.3 SPECIFICATIONS
 - 2.4 ADVERTISEMENTS/MARKINGS

3. TESTING - PROTOCOL
 - 3.1 TESTING PROCEDURE
 - 3.2 TESTING INSTITUTE
 - 3.3 SERVICES

4. APPROVAL - REQUIREMENTS
 - 4.1 GET APPROVED
 - 4.2 STAY APPROVED
 - 4.3 CHANGES
 - 4.4 WITHDRAW APPROVAL
 - 4.5 FEES
 - 4.6 PENALTIES

5. EXPLORE - LIST
 - 5.1 LIST OF ITTF APPROVED NET GAUGES

6. ANNEX
 - 6.1 TERMS OF REFERENCE
 - 6.2 DEFINITIONS OF TERMS AS USED IN THIS DOCUMENT



1.1. INTRODUCTION

At present, net gauges are not applicable equipment for approval by ITTF. Nevertheless, net gauges have a very important role to keep the matches fair such that:

- (i) the result of a rally should not be influenced by the net condition or
- (ii) a net gauge can indicate illegality of players' racket.

Net gauges can also be used for the detection of glossy surfaces of rubbers.

Therefore, the ITTF intend to regulate the specifications or requirements of the net gauge as "Technical Guidelines". Umpires should use only a net gauge conforming to the requirements described in this "Technical Guidelines" document **Manual**. The responsible person should check the capability of umpires' net gauges, not only for using as a net gauge, but also when it will be used as a tool for Racket Control, before starting the tournament.

How to check or adjust the tension and the height of the net by using net gauge, **is Those are** concretely described in **Technical Leaflet T2 Manual M2** - The Net Assembly. It is strongly recommended to first adjust for tension and then for height.

How to check the thickness of rubbers with net gauge, **it** is described in detail in **Technical Leaflet T9 Manual M9** - Racket Control.

1.2. ITTF LOGO AND TRADEMARK

The ITTF approved net gauges are identified by their brand names and by the ITTF logo, or other ITTF indications. They must wear the ITTF logo wherever they are sold or used! All names must be in Roman or Latin letters, and additionally they may be in another language. The name may contain numbers.

The ITTF will make its best effort to ensure that the trademark or brand name does not infringe on the already existing net gauge brands. The ITTF is not responsible for any illegal use of registered trademarks. Verifying the correct and legal use of trademarks is not part of the ITTF approval procedure.

1.3. CONTACT

ITTF Equipment Office
Kaesenstrasse 17
50677 Cologne - GERMANY
Tel: +49 221 42343366
E-mail: equipment@ittf.com

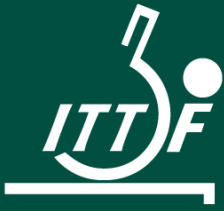

STANDARDS





2. STANDARDS TO ACHIEVE

Two types of net gauges are wholly used by umpires:

1. **Light net gauges Standard net gauge:** They are to be used for the adjustment of the height of the net, at about 30 cm from the net posts. **Specifications and dimensions are given in figure 1.**
2. **Heavy net gauges Net tension gauge:** They are to be used exclusively for the adjustment of the net tension, in the middle of the net. This cannot be used for adjusting the net height. **Specifications and dimensions are given in figure 2.**

- correct, safe or quick determinations of the tension of the net: 3
- reliable checks of the thickness of racket coverings: 1,2,5,6
- correct checks of the flatness of racket sides: 2,4

Additionally, to the above functions of the net gauge, a **light net gauge standard net gauge** may often be used to check the extensions, flatness and thickness of the rubbers on a player's racket as well as the height of the cushions of the wheelchairs.

2.1. PRODUCT AND BRAND

The name of a product is always composed by the brand name and the net gauge type name. Both together define the product in a unique way so that confusions will be avoided and consumers are correctly informed.

If the responsible person **ITTF** confirms that a net gauge satisfies all the requirements **within this manual** shown in table 1, he/she gives the approval **will be given** to the **supplier brand** to use the ITTF logo **and the manufacturing date** on the net gauges.

The approval is only valid for the specific manufacturing series and any changes for future manufacturing series should first be approved by the ITTF.

2.2. MANUFACTURING

ITTF recommends manufacturers and brand to strictly apply the technical and other legal regulations of the user's home countries. The ITTF cannot be held responsible in case of non-observance of any additional or different national request; the ITTF approval sets up ITTF standards guaranteeing a safe and reliable table tennis at top-level events.

New materials, new manufacturing processes or a change of the producer, what could result in different properties, need to be announced to ITTF and require new testing.



2.3. SPECIFICATIONS

All net gauges may have a height of about 180 mm. Their width shall be less than 48 mm (**net tension gauge** (heavy gauges)) and less than 42 mm (**standard net gauge** (light gauges)) but slimmer is better. Their thickness shall be 2.0 mm so that they can be used for determining the extension of the racket covering up to or beyond the edges of the blade **as recommended in HMO 7.1.1**. As net gauges can also be used for the detection of glossy surfaces at an angle of about 45°, their background may be dark and letters or logos may be white.

Figures 1 & 2 draw basic shapes for net gauges used at ITTF tournaments. Other features may be added but may not change a basic requirement as described in table 1 **and 2** and in the text.

The design of a net gauge shall allow it to hang vertically on a cord. If it does not, the centre of gravity of its plane is located outside its medium vertical axis, which may lead to incorrect measurements because the lower part of the gauge will touch the net. For the same reason, the central split may not be narrower than 7 mm.

On one side the net gauge shall have an incision of 4.0 mm with a tolerance of +/- 0.05mm, and on the other side it may have an incision of 2.0 mm with a tolerance of +/- 0.05mm. The angles of the projecting part at the top of the incisions must be 90° exactly and rounding on the outside or inside corners is strictly prohibited. The height of the lateral incisions shall not be less than 152.5 mm, so that both long edges can be used for flatness checks.

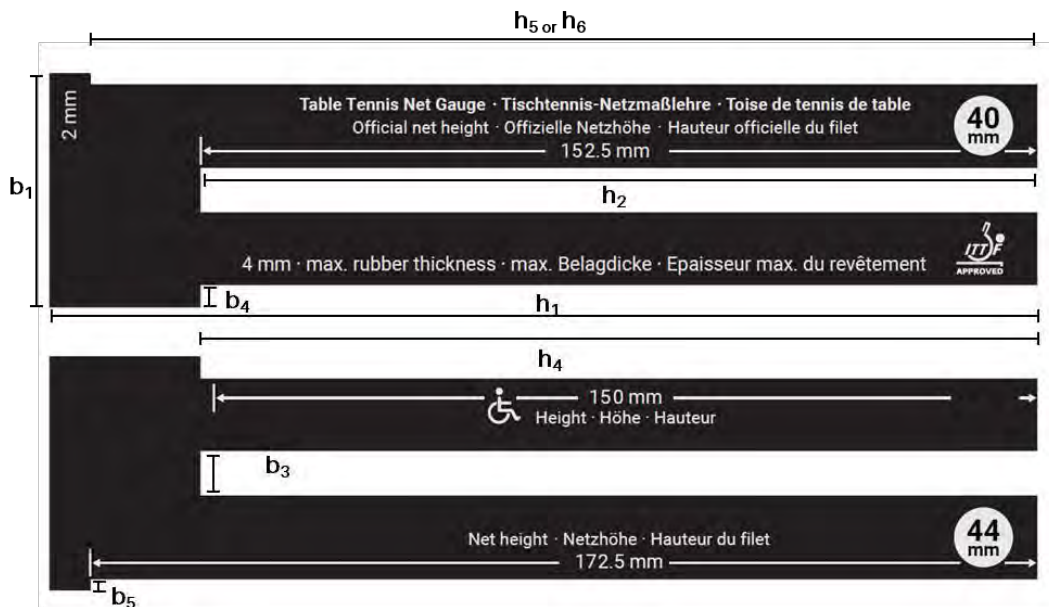

Figure 1: Standard Net Gauge (Light Gauge)



The market presently provides **net tension gauges** (heavy gauges) with a central split, open up to 15 mm, for the height.

As long as the **net tension gauges** (heavy gauge) can hang vertically and safely on the net for the height of 142.5 mm, its central split is acceptable for the tension adjustment (but should not be used for the height adjustment). Lateral incisions are not made for tension adjustment; height adjustments are possible but they are fussy and questionable. Therefore, lateral incisions may not be used for adjusting the tension or the height of the nets. Lateral edges must be straight because gauges are used for the check of thickness and flatness of the rackets.

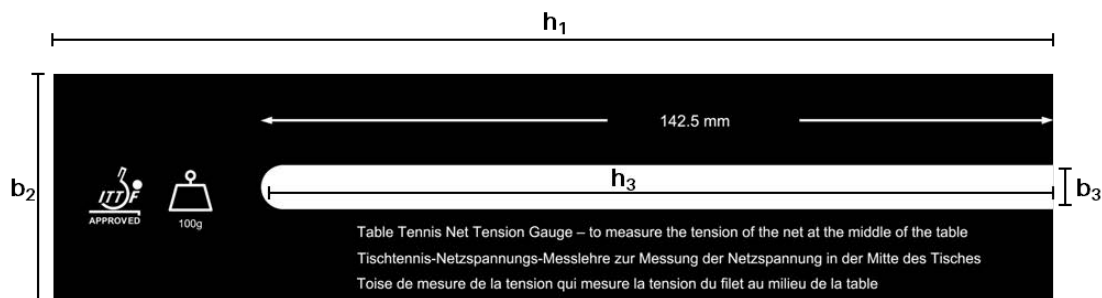

Figure 2: Net Tension Gauge (Heavy Gauge)



2.3.1. DIMENSIONS - STANDARD NET GAUGE

	Code	Description	Dimension [mm]	Fig.
Standard Specifications	-	background colour/lettering colour	dark/white	1/2
	h_1	height	~180	1/2
	b_1	width	≤ 42	1
	t	thickness	2.0 ± 0.1	-
	-	weight (in g)	< 15	-
	-	Vertical hanging on the net cord	balanced	-
	h_2	height of central split	152.5	1
	b_3	width of central split	7 - 12	1/2
	-	roundness of central split top	straight	-
Lateral incisions (for racket covering thicknesses)	b_4	depth of lateral incision (for racket covering with sponge)	4.0 ± 0.05	1
	h_4	height of lateral incision (for racket covering with sponge)	152.5	1
	-	Sides of lateral incision top (at height h_4)	straight	-
	-	Inner Corner on top of the lateral incision (at height h_4)	90° sharply	-
	-	Outer Corner on top of the lateral incision (at height h_4)	90° sharply	-
	b_5	depth of lateral incision (for racket covering without sponge)	2.0 ± 0.05	1
	h_5	height of lateral incision (for racket covering without sponge)	152.5	1
	h_6	height of lateral incision (for racket covering without sponge)	172.5	1
	-	Sides of lateral incision top (at height h_5 or h_6)	straight	-
	-	Inner Corner on top of the lateral incision (at height h_5 or h_6)	90° sharply	-
	-	Outer Corner on top of the lateral incision (at height h_5 or h_6)	90° sharply	-

Table 1: Dimension of the standard net gauge [mm]



2.3.2. DIMENSIONS - NET TENSION GAUGE

	Code	Description	Dimension [mm]	Fig.
Standard Specifications	-	background colour/lettering colour	dark/white	1/2
	h_1	height	~180	1/2
	b_2	width	≤ 48	2
	t	thickness	2.0 ± 0.1	-
	-	weight (in g)	$100 \pm 0,5 \pm 1$	2
	-	Vertical hanging on the net cord	balanced	-
	h_3	height of central split	142.5	2
	b_3	width of central split	7 - 12	1/2
	-	roundness of central split top	round	-
Lateral incisions (for racket covering thicknesses) only optional	b_4	depth of lateral incision (for racket covering with sponge)	4.0 ± 0.05	1
	h_4	height of lateral incision (for racket covering with sponge)	152.5	1
	-	Sides of lateral incision top (at height h_4)	straight	-
	-	Inner Corner on top of the lateral incision (at height h_4)	90° sharply	-
	-	Outer Corner on top of the lateral incision (at height h_4)	90° sharply	-
	b_5	depth of lateral incision (for racket covering without sponge)	2.0 ± 0.05	1
	h_5	height of lateral incision (for racket covering without sponge)	152.5	1
	h_6	height of lateral incision (for racket covering without sponge)	172.5	1
	-	Sides of lateral incision top (at height h_5 or h_6)	straight	-
	-	Inner Corner on top of the lateral incision (at height h_5 or h_6)	90° sharply	-
	-	Outer Corner on top of the lateral incision (at height h_5 or h_6)	90° sharply	-

Table 2: Dimension of the net tension gauge [mm]



2.4. ADVERTISEMENTS/MARKINGS

There are no rules for advertisements/markings on the net gauges, other than

- The ITTF logo shall only be used for net gauges that have been approved by the ITTF.
- The brand name or brand logo must be visible.
- The model name is indicated (Standard net gauge or Net tension gauge)
- All relevant dimensions shall be properly indicated on the gauge:
 - o Lateral incisions (4.0 mm or 2.0 mm)
 - o Indication for official net height with 40 mm ball (152.5 mm)
 - o Indication for net height with 44 mm ball (172.5 mm) (optional)
 - o Along one of its edges the net gauge shall have a ruler of 15cm 150 mm scaled in mm so that it may serve for measurements as the height of the cushions of wheelchairs (see figure 1). (optional)
 - o 100 g weight marking or symbol (only for net tension gauges).



Figure 3: ITTF logo

For more information, please refer to the ITTF Branding Guidelines. Both, the guidelines and the versions of the ITTF logo, can be requested from ITTF Equipment Department.

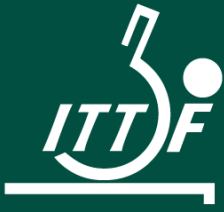

TESTING





3. TESTING-PROTOCOL

3.1. TESTING PROCEDURE

PREPARATION FOR TESTING LABS

The brand or manufacturer has to send the net gauges to the testing lab, mentioned under 3.3.

SEQUENCE OF TESTING

1. Net gauge specifications
 - a. Eyesight inspection
 - b. Tactile inspection
 - c. Markings/advertisements
 - d. Net gauge dimensions
2. Report (in ITTF Approval Forms)

After the testing and receiving the results, the net gauges will be kept in ITTFs archive.

PREPARATION FOR ITTF EQUIPMENT OFFICE

The brand or manufacturer has to send the following samples to the Equipment Office:

- Standard net gauge (if applied for) with original packaging (if available)
- Net tension gauge (if applied for) with original packaging (if available)

3.1.1. EYE-SIGHT AND TACTILE INSPECTION

Gauges showing any of the following, but not limited, defects shall not be used, because they do not allow:

- Edges not straight (1) and (4)
- Inside corner rounded (2)
- Top of the tension split straight (3)
- Rounded outside corner at the top of a lateral incision (5)
- Lateral incision depths different to 4.0 or 2.0 mm (6)

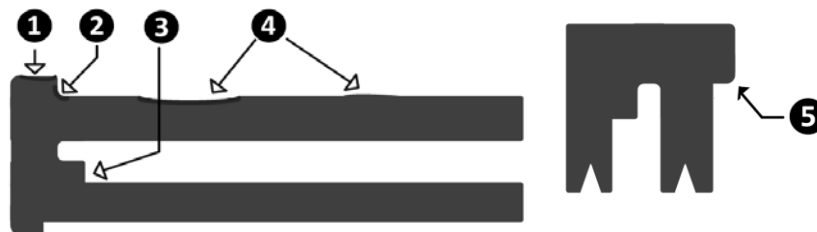

Figure 4: Prohibited defects of net gauges



3.1.2. DIMENSIONS

A vernier caliper, a large size, 200 mm, is recommended for checking each dimension of a net gauge. You can buy it at any tools shop. You don't need to select a high precision one. All dimensions will be measured with a digital caliper gauge (KYNUP; 300 mm; accuracy to ± 0.0015 inches/0.03 mm)

3.1.3. WEIGHT

The weight of the net gauges will be measured with a high precision scale (KERN PNJ 600-3M).

3.2. SELF-TESTING

There are two testing to check the 2.0 mm or 4.0 mm literal incisions on the standard net gauge and net tension gauge, when using a new net gauge, for example during an event:

1. Easy method for checking the net gauge by using Using metal pins. The accuracy of the diameter of the metal pins should be 3.95 mm ~ 4.00mm.

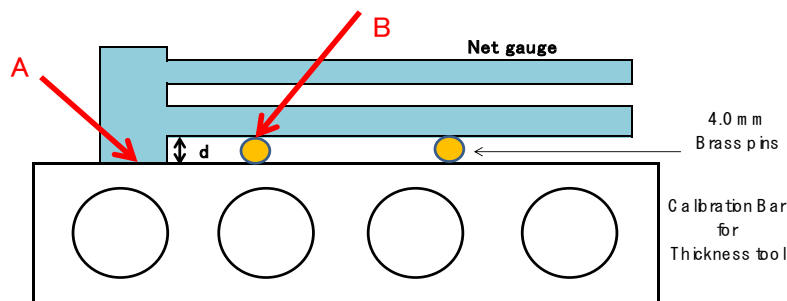

Figure 5: Easy Method for checking the net gauge, by using metal pins

- 1) d of net gauge ≤ 4.0 mm \rightarrow any gap will be found at A (tolerance ≤ 0.1 mm)
- 2) d of net gauge ≥ 4.0 mm \rightarrow any gap will be found at B (no tolerance)

2. The easy method for checking the net gauge is by using Using the digital thickness device for racket coverings. This method is suitable to check the net tension gauge (heavy net gauge) but not the standard net gauge (light net gauge) because of bending under the weight of the digital device.



Figure 6: Easy method for checking the net gauge by using the digital thickness device



3.3. TESTING LAB



Kaesenstrasse 17
50667 Köln
GERMANY

3.4. SERVICES

Any brand bearing an approval of one or more products is invited to seek further explanations to the results of testing, to matters of calculation, statistical evaluation or – as far as confidentiality is not affected – general benchmarks from the ITTF net gauges testing results database. Such service is included in the approval fee.

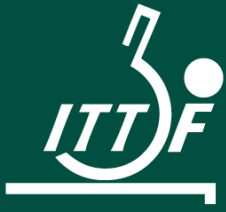

APPROVAL





4. APPROVAL - REQUIREMENTS

The following document is a guide how to announce a table tennis net gauge for ITTF approval. This requires the net gauge to bear our standards for an ITTF APPROVED net gauge.

The ITTF Quality Program for net gauges was developed with the aim of improving the quality throughout the world.

4.1 GET APPROVED

NEW BRAND REGISTRATION

A new brand, who wishes to enter in relationship with the ITTF and before the approval procedure can be started, needs to

- apply for registration by completing the online-form "Net Gauge - Approval Form"

The ITTF reserves its right not to accept a company as a brand, for table tennis goods.

The ITTF cannot be held responsible for wrong or misleading information, or for names illicitly used by the brands.

OFFENSIVE TRADEMARKS/BRANDS

It is at the ITTF's own discretion to refuse a brand the possibility to join or continue being part of the ITTF Equipment Approval Scheme, in case of use of logos or advertising that would be considered offensive or adverse to ITTF policies.

BRANDS UNDER PLAYERS' NAMES

In case of an application by a company using a top level player's name or part of his/her name as brand name, the ITTF at its own discretion can ask the company to provide a written confirmation by the player before processing the application.





BRANDS WHO PREVIOUSLY USED THE ITTF TRADEMARK ILLEGALLY

The ITTF can refuse the application from companies who previously used the ITTF trademark for non-approved equipment under the same or different brand name on the application. The ITTF can further refuse the application from a brand who may have obtained the rights from the previous brand, who illegally used the ITTF trademark for non-approved equipment.

APPROVAL SCHEME

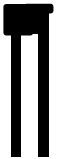
Please see the application process for the company and the net gauge testing below. Note that each step must be completed before the next one can be started.



STEP 1  DOCUMENTS	Applicants	Provide the following documents by email to the ITTF Equipment: <ul style="list-style-type: none"> The net gauge form with application and dimensions: <ul style="list-style-type: none"> sheets should be filled in and signed (one EXCEL and one signed PDF) All annexes mentioned in the end of the "Dimensions" sheet of the approval form
	ITTF	After the above-mentioned documents are received, ITTF will send an email confirming all documents are correct or something is still missing or needs to be modified.
STEP 2  NET GAUGE TEST	Applicants	Please send the following samples: <ul style="list-style-type: none"> Standard net gauge sample (if) Net tension gauge (if) Packaging (if)
	ITTF	ITTF will send an email informing about the test order, required sample and include an invoice for the net gauge test.
STEP 3  LICENSE AGREEMENT	Applicants	Please transfer the requested amount according to the received invoice.
	ITTF	Once the testing fee has been paid the ITTF will inform about the test results. If the net gauge has passed all official tests, the applicants can request the time they want the approval of their net gauge to become effective. The ITTF will send the invoice of the approval fee for the current year.
STEP 4  PAYMENT	Applicants	Please transfer the requested amount according to the received invoice.
	ITTF	The ITTF will confirm receipt of the invoice amount.
STEP 5  APPROVAL	Applicants	Please inform the ITTF when they should publish the approved product on the ITTF equipment website.
	ITTF	The product is now ITTF approved and online on the ITTF list of approved net gauges.



4.2. STAY APPROVED

If we do not get any message that one of your products should be withdrawn, we will send you at the end of the year a mail to confirm that all products should stay approved. Afterward we will send the invoice about the approval fee for the coming year. After we received your payment all products will stay on our lists.

RE-TESTING OF NET GAUGES

In case of concerns about the structure and quality of a specific net gauge, the ITTF can order a re-test of the net gauge at the brands costs: if the net gauge does not respond to the expectations of M5, the net gauge will be withdrawn from the list of ITTF approved net gauges. Approval-fees already paid will not be reimbursed.

Periodic re-testing of approved net gauges can be organized by the ITTF on the brands costs in order to make sure that all requirements of M5 are observed, that changes of M5 have been correctly applied to all net gauges and that substantial changes at individual net gauges have been authorised by the ITTF before their implementation.

4.3. CHANGES

Any change relevant for ITTF approval must be notified to the ITTF. The changes must be confirmed by the ITTF in writing.

The failure to announce changes to the ITTF will be penalized with a fine or can even lead to an end of the ITTF approval in cases of severe or repeated failures. It is the company's responsibility to inform the ITTF, in case they have changes in contact details, such as e-mail addresses, contact persons, postal address etc.

BRAND OWNERSHIP

If a company takes over the brand name from another company, who owes money to the ITTF, the equipment will remain approved only if the new owner submits a letter of confirmation, signed by the old and new owner, ensuring that all the rights and debts towards ITTF of the brand were transferred to the new owner. The ITTF will inform the new owner about delinquent payments, if any, which should be settled. Otherwise, the equipment will be removed from the ITTF Lists.

4.4. WITHDRAW APPROVAL

If the approval of one of your products shall be withdrawn, please send us a corresponding mail. The cancellation period is 1 year. After confirming your cancellation, the product will be marked with the expiring date, which means 1 year from the confirmation date on.



4.5. FEES

Please contact us to get the valid fee list.

TESTING

On behalf of your order to approve a net gauge we will charge a testing fee to you after we received your samples. This testing fee must be paid independently from the result of the testing.

If a net gauge does not pass the testing, it is your choice to stop the approval process, or send new samples. In this case we will charge the second testing like the first one, under the same conditions.

FIRST APPROVAL

After your net gauge has passed the testing, we will charge an approval fee for the rest of the year.

YEARLY APPROVAL

In order to be able to keep the products on the list of ITTF Approved net gauges, the brand must pay the yearly approval fees for the net gauges.

ITTF will send an invoice at the end of the year, valid for the approval of the coming year. Payment receipt must be before the new year started to keep the products on our lists.

CANCELLATION PERIOD

The cancellation period for net gauges is 1 year. 50 % withdrawal fee will be charged for this period.

CERTIFICATE

For all of your approved net gauges you will get a yearly valid certificate.

4.6. PENALTIES

The ITTF can fine, suspend or delete brands from its directory and suspend or delete their products from its lists in case of infringements or situations affecting negatively the table tennis game or the reputation of the ITTF or if they commercialize substances or products banned by the ITTF, after taking into account written explanations of the company about the problem.

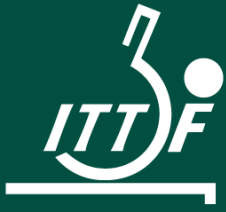

EXPLORE





5. EXPLORE-LIST

5.1. ITTF APPROVED NET GAUGES

Under <> you can find all currently approved net gauges in our data base.
New products and withdrawn ones are marked accordingly.

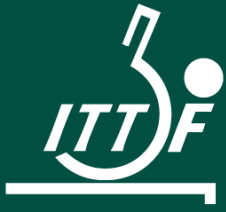

ANNEX

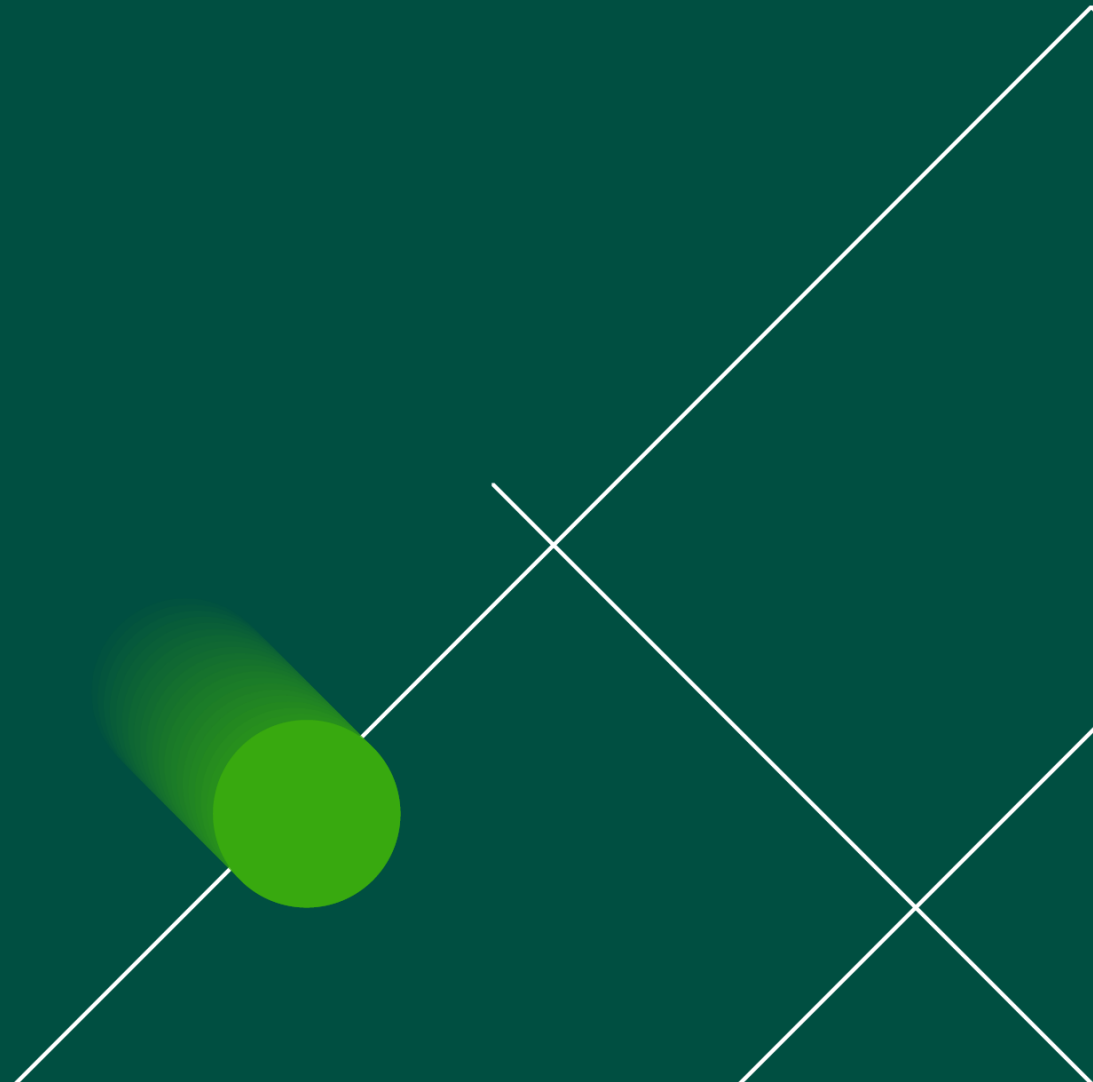



6. ANNEX

6.1. TERMS OF REFERENCE

The Laws of Table Tennis relating to the net gauges are as follows:

- 2.2.3 The top of the net, along its whole length, shall be 152.5mm above the playing surface.
- 2.4.1 The racket may be of any size, shape or weight but the blade shall be flat and rigid.
- 2.4.3 A side of the blade used for striking the ball shall be covered with either ordinary pimples rubber, with pimples outwards having a total thickness including adhesive of less than 2.05mm, or sandwich rubber, with pimples inwards or outwards, having a total thickness including adhesive of less than 4.05mm, subject to any margin of tolerance specified in the relevant technical equipment document.
- 2.4.4 The blade, any layer within the blade and any layer of covering material or adhesive on a side used for striking the ball shall be continuous and of even thickness. Material suitable to shape a handle for holding the racket may be added on.

The Regulations in Manual M2 – Net Assembly state as follows:

- 2.10 The tension of the net cord may be checked in the middle of the table either by using fingers or, preferably, by a 100g net tension gauge heavy tension gauge. The 142.5mm high part of the gauge should hang on the net; the tension is correct if the bottom of the gauge comes next to the table-top surface without touching it. Otherwise, the devices to adjust the net tension must be operated.

The height of the net shall be checked about 30cm from the upright posts: it shall reach the correct height. The height should preferably be adjusted with the standard net gauge normal light net gauge that does not depress the net: the bottom of the freely and vertically hanging gauge should just touch the table-top. Otherwise, the devices to adjust the net height have to be operated until the 152.5mm are reached everywhere.

The Regulations in the Directives for PTT Events (for Wheelchairs):

- 3.15.3 The height of one or maximum two cushions are limited to 15 cm in playing conditions with no other addition to the wheelchair.



6.2. DEFINITIONS OF TERMS AS USED IN THIS DOCUMENT

Approval	The certification for conformance to the technical standards as set by the ITTF, for shared playing equipment like balls, nets, net gauges, sports floors and tables.
ITTF Lists	Lists of ITTF Approved Equipment
Manufacturers	Companies producing equipment
Companies	Official companies who have a registered brand
Brand	Registered brand
Product	Particular name used to describe a specific product of a brand.
Testing	The series of tests and measurements required to verify quality, safety and compliance with ITTF requirements in order to get approval by the ITTF.
Re-testing	Any repeated testing either because of a prior failed test, of a periodically scheduled quality inspection, or of a problem with a specific model.
Full testing	Full testing includes all tests and measurements defined in the manuals.
Partial testing	selects the tests and measurements needed for the purpose of the testing.
Quality	All regulations and measures targeting to provide customers and users with the assurance best-quality equipment, manufactured in full respect of ITTF technical and safety standards and marketed/labelled in a complete, non-misleading way.
Final Approval	The equipment item fulfils all ITTF requirements.
Withdrawal	Approval discontinued, when requested by the brands.
Suspension	Approval provisionally or temporarily discontinued, when decided by the ITTF.
Deletion	Approval permanently discontinued, when decided by the ITTF.
Infringement	Any action of violation of the ITTF policies, laws and regulations.

End of M5



ITTF QUALITY PROGRAMME

FOR RACKET CONTROL - MANUAL 9



January 2026



1. INTRODUCTION
 - 1.1 TERMS OF REFERENCE
 - 1.2 CONTACT
2. REGULARITY OF BLADE AND RACKET COVERINGS
3. AUTHORISATION OF RACKET COVERINGS
4. TEST FOR VOLATILE ORGANIC COMPOUNDS
 - 4.1 PRINCIPLE AND RATIONALE
 - 4.2 MINIRAE-LITE SETUP
5. FLATNESS TEST
 - 5.1 ELECTRONIC FLATNESS DEVICE
 - 5.2 ELECTRONIC FLATNESS DEVICE WITH ADJUSTABLE FEET
 - 5.3 MANUAL FLATNESS DEVICE - NET GAUGE
 - 5.4 PRINCIPLE AND RATIONALE
6. THICKNESS TEST
 - 6.1 ELECTRONIC THICKNESS DEVICE
 - 6.2 OPTICAL THICKNESS DEVICE - LOUPE
 - 6.3 MANUAL THICKNESS DEVICE - NET GAUGE
 - 6.4 PRINCIPLE AND RATIONALE
7. DISMANTLING RACKETS
 - 7.1 PROCEDURE
 - 7.2 RACKET COVERING CHECKS
 - 7.3 BLADE CHECKS
 - 7.4 CONCLUSION
8. OPTIONAL TESTS
 - 8.1 PIMPLE DENSITY
 - 8.2 COLOUR
 - 8.3 GLOSS
9. SANCTIONS
 - 9.1 VOLUNTARY TEST
 - 9.2 PRE-MATCH RACKET CONTROL TEST
 - 9.3 POST-MATCH RACKET CONTROL TEST
10. APPENDIX - SUMMARY OF RACKET TESTS



1. INTRODUCTION

This Manual describes the tests used in a racket control center. While the tests are generally designed to verify that every racket fulfills the requirements of the ITTF Laws of Table Tennis and the ITTF Regulations for International Competitions, they also include additional tests as approved by the ITTF Council.

The primary functions of the racket tester are to inspect and measure rackets, record results, and communicate with other officials. A racket tester cannot validate or disqualify a racket; he or she can only test the racket and report the findings to the necessary umpire or referee. Through the course of a competition, a racket tester will handle the rackets of many players. It is important to handle rackets with care, understanding that each racket is a vital tool of a professional player. Specifically, rubber surfaces should not be touched with bare fingers. If a racket must be adjusted, such as trimming of edges or removal of tape, it is recommended that this be done by the player.

A description of each test follows. Appendix lists each test and its respective limit for quick reference.

During the past decades, with increasing industrial capabilities, the table tennis racket has become a sophisticated piece of equipment. This may be beneficial for the players and spectators, however to use equipment which has almost unlimited variations and possibilities requires certain minimum standards. An example is the use of speed glue which, at a first glance, brought more power to the game; but bore the risk of health issues. In addition, even when driven to perfection, the behavior of equipment should not be unpredictable for the opponent.

This need for minimum standards necessitated the creation of Laws and Regulations regarding the racket and instituted the concept of racket control. The purpose of racket control is to contribute to the fairness for which table tennis is known. Racket testing will not detect every possible deficiency by total control; the concept is to keep deficiencies within a reasonable range that will ensure fair play.

A racket tester should not be guided by the ambition to detect fraud but assist players in optimizing their fair play. A breach of the Laws and Regulations for rackets definitely needs to be penalized, but may nevertheless be unintentional, and unless the contrary is obvious, this is what should be assumed in favor of the player who might simply try to optimize his equipment legally. This of course does not preclude keeping an eye on the characteristics of rackets and their owners throughout a tournament.

Especially in professional play, the table is the players' workplace. Racket testing should assist them and, to do so, requires additional duties of them, but should not be an unnecessary burden.

1.1. TERMS OF REFERENCE

The principal Laws and Regulations which guide racket testing are:

- 2.4 The Racket
- 3.2.1.3, which describes the use of racket coverings
- 3.2.4 Racket Control



1.2. CONTACT

ITTF Equipment Office
Kaesenstrasse 17
50677 Cologne - GERMANY
Tel: +49 221 42343366
E-mail: equipment@ittf.com

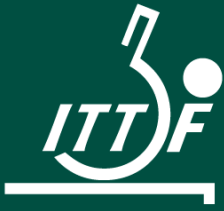

REGULARITY OF BLADE AND RACKET COVERINGS





2. REGULARITY OF BLADE AND RACKET COVERINGS

Visual inspection is the first thing that a racket tester should do when he receives a racket. A racket should always be checked to see that it satisfies the basic requirements of a table tennis racket. These include:

- **Colour** - There must be one coloured side and one black side.
- **Wooden Blade** - The blade must be composed mostly of natural wood, though layers of other fibrous reinforcement materials are permitted. The surface of the blade may have a thin layer of lacquer, but not coated with paint or very thick lacquer over 0.1 mm thick.
- **Surface Regularity** - The racket covering must be flat, continuous, and have a regular appearance such as in texture and colour. The racket covering should extend up to the limits of the blade, though the referee may provide guidance regarding the tolerance to be permitted.
- **Damage** - The referee should provide guidance to describe the amount of racket damage that will be tolerated. In general, slight damage around the edge of a racket may be permitted depending on the extent; but significant blade damage, or a crack, chip, or missing pimple in the hitting area usually will have to be reported and the referee decides if an exchange of the racket is required or not. Damages during the game can lead to an exchange of the racket as well.
- **Attachment of Topsheet, Sponge and Blade** - The racket covering must be completely attached to the blade. Problems in this regard may be directly visible, but during inspection the tester should be careful not to risk further detachment. The referee will make the final ruling.
- **Treated Rubber** - Racket coverings must not be treated, i.e. its physical or chemical properties must not have been changed, whether deliberately or not. This is difficult to declare with certainty, unless a reference rubber in the original state is available for comparison. However, it can always be checked that the surface of the racket covering should be clean and free of any additional substance or materials.
- **Other Irregularities** - There are many additional conditions which may cause a racket to be considered irregular and not permitted for competition. There are also many irregularities which would be considered acceptable. For example, a part of the blade near the handle might be uncovered, or covered with different materials; this would normally be accepted if this area is covered by the player's hand. Or the back side of a penhold racket might be covered with paint, or plastic. Again, this is permitted, provided that it is matt and the colour is black or bright colour. The use of rubber material or unauthorised racket coverings, that is similar to an authorised racket covering is not allowed, even on a side not used for striking the ball. When in doubt, the racket tester should note the irregularity and inform the referee, who will make the final decision.

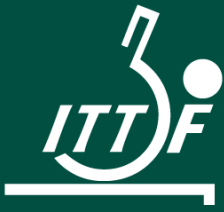

AUTHORISATION OF RACKET COVERINGS





3. AUTHORISATION OF RACKET COVERINGS TESTING

Racket coverings (rubber) must be on the current List of Authorised Racket Coverings (LARC) published by the ITTF. The rubber must have the brand name, product name and the ITTF logo. In addition, if the rubber exists only with an ITTF number on the LARC, then the ITTF number on the rubber is also mandatory. Be aware that some racket coverings have two versions, one with and one without a number, and in these cases the ITTF number on the rubber is not required.

The latest LARC is available on equipment.ITTF.com in the Racket Coverings section. It is updated daily, and all new rubbers are authorised with immediate effect while all rubbers that have been removed lose their authorisation with immediate effect. Note that National Associations may extend the period of validity for their national play.

As an exception, racket covering that were authorised on the first day of a tournament shall be valid for use until the last day of this tournament, even if any changes have occurred in the LARC in between.

When doing a lookup of the covering in the LARC, note that the list is not purely alphabetical. For each brand, all rubbers which have an ITTF number are first, followed by all rubbers without numbers. Therefore, you will find a "Megabrand 001 Toprubber" far before a "Megabrand Superrubber".

The branding area on a racket covering can contain additional text or wordings than the above listed requirements (brand name, product name, ITTF Logo and ITTF number) in case the branding area fits with the published artwork on ITTF equipment website. If the markings do not match, the racket covering is not authorised.

If other branding/marketing difficulties arise, the referee retains the final decision.

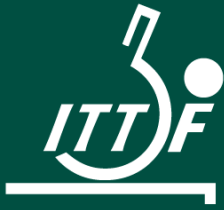

TEST FOR VOLATILE ORGANIC COMPOUNDS





4. TEST FOR VOLATILE ORGANIC COMPOUNDS

Volatile organic compounds (VOCs) have been banned by the ITTF. The current limit is 3.0 ppm, but it may change if decided by the ITTF Executive Board. VOCs are measured using the MiniRAE-Lite device. Setup and calibration of the device is described in 4.2.

TEST PROCEDURE

1. Prior to measuring each side of a racket, read the background VOC level by turning the cap to the open air. Record the background reading on the Racket Control Report Form.
2. Apply the cap to the middle of the rubber surface for 20 seconds, with gentle hand pressure to enclose the cap but not compress the rubber. Write the reading on the same form. The difference between the reading after 20 seconds and the background reading is the "real reading".

Racket Coverings	coloured side	black side
VOC Background level reading (A)		
VOC Reading after 20 seconds (B)		
VOC Reading result (B-A)		

3. Repeat the same procedure with the other side of the racket. Before doing so, remove the cap from the racket and allow the system to aerate until it reaches the previous background level.
4. In those competitions where a second RAE equipment is available, and when a racket is found with a reading over the allowed limit, the second device shall be used to confirm the result of the first measurement. If the second device also gives readings above the acceptable level then it is clear that the racket has failed the test. However, if the second device gives readings below the defined limit then the racket is deemed to be within acceptable limits.
5. To turn off the instrument, press and hold the MODE key for 3 seconds, and a 5 second countdown to shut off begins. Once the countdown stops and the display shows "Unit off..." release the MODE key, and the instrument is now switched off.

When using the MiniRAE-Lite, it should be taken into account that the tolerance of the reading is $\pm 10\%$. So, a player should not receive any disciplinary action if his or her racket does not release more than the limit stated by the ITTF Executive Board plus a 10% allowance of this limit. E.g.: if the limit is 3.0 ppm, the tolerance would be ± 0.3 and the maximum reading that a racket covering may release would be 3.3 ppm.

4.1 PRINCIPLE AND RATIONALE

The release of Volatile Organic Compounds (VOC) must be tested because it is a requirement of Regulation 3.2. The reason for this is that table tennis, like all other sports, should consider the health of players, spectators and all others involved. To do so, first speed gluing and then boosting and any other treatment of rubbers was declared illegal. The purpose of the VOC test is to ensure that at the time of the match, when the equipment is present in the venue, there is no VOC exposure which may be harmful or may give an unfair advantage to a player.

It is ITTF's strong conviction that the ban of VOCs is in favor of all players not only because of the health issue; in addition, for example, using VOCs deliberately (such as in speed gluing) requires application

shortly before the match and therefore has only disturbed the reasonable match preparations of players and their coaches.

When executing a VOC test, the background level B is subtracted from the "gross reading" A (final display after 20 secs) in favor of the player, because the result is the lower bound of possible VOC levels coming from the racket itself. If a racket has in fact zero VOC emissions, this is trivial because the reading A will equal the reading B. If a racket has in fact VOC emissions of $3 \times B$, three times the background B, the reading A will be at most $4 \times B$, so the result counting is at most $4 \times B - 1 \times B = 3 \times B$.

It is in the nature of VOC emissions that the first seconds of the test will already show the direction of the journey: If after 10 seconds the reading did not change at all, it is very likely that the same holds after 20 seconds. In busy situations, consideration may be given to this fact.

On the other hand, precision is crucial in close cases. For example, a reading reaching the limit after exactly 20 seconds is an acceptable result, no matter how fast it is increasing from the 21st second on. Another example, if the racket tester is not sure whether he or she had a precise look at the timer, there is no harm in just repeating the measurement while keeping a closer eye on the stopwatch.

4.2. MINIRAE-LITE SETUP

The MiniRAE-Lite is currently used by the ITTF and is a photoionization detector (PID) which uses ultraviolet (UV) light to break down chemicals to positive and negative ions that can be easily measured.

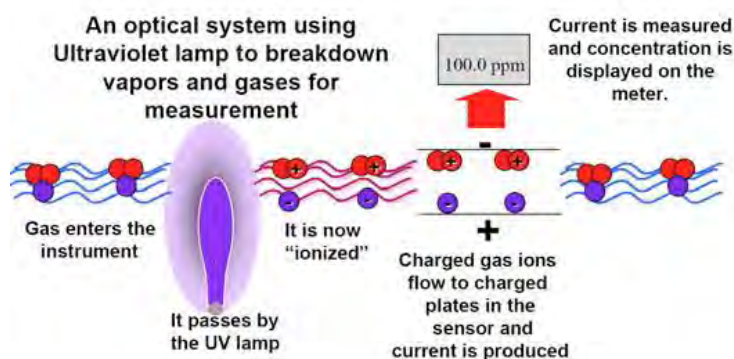

The instrument's user interface consists of the display, LED's, an alarm transducer, and four keys. The keys are:

- Y/+
- MODE
- N/-
- Flashlight On/Off

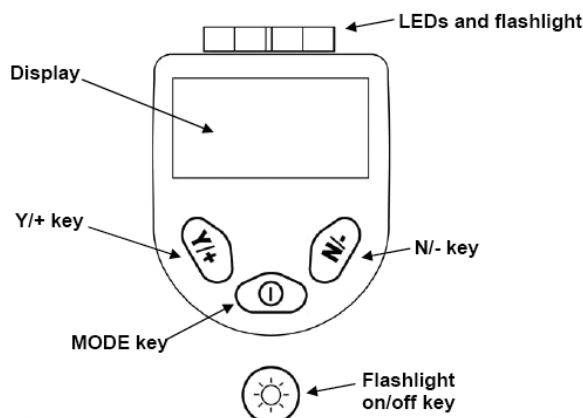

The display shows the following information:

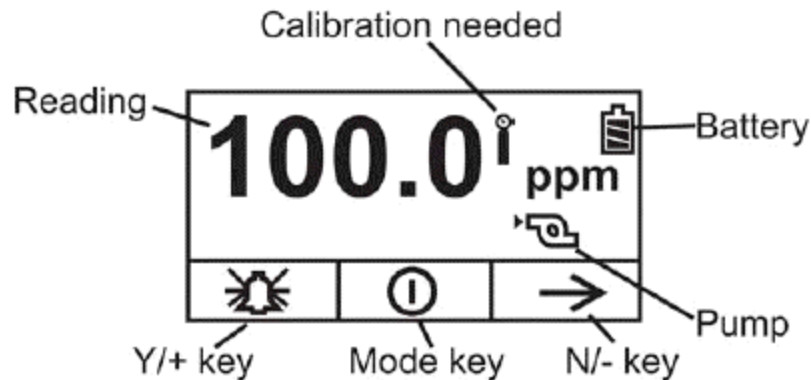

For proper measurement on the surface of the coverings of the racket, the device is used together with a special cap connected by two tubes to the MiniRAE Lite. These tubes shall be of PTFE Teflon. A filter supplied by RAE shall be used to reduce the effects of the humidity and dust. If there is a mark "INLET" on the filters, that side of the filter should face away from the device. The filter shall be changed every two events, in the case of competitions with duration of a maximum of 5 days. For World Championships the filter shall be changed once in the middle of the competition. For Olympic and Paralympic Games the filter shall be changed twice during the competition.

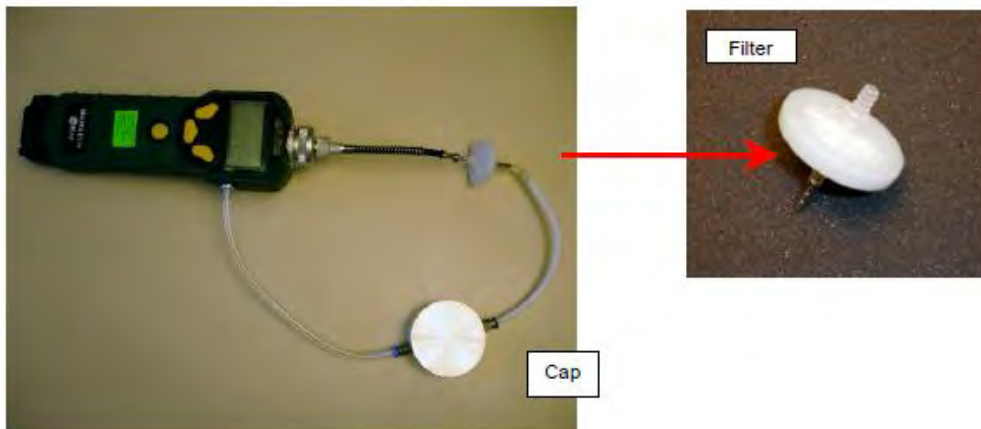

DEVICE SETUP

1. Connect the air outlet tube, which is with the device, to the threaded hole in the right side of the instrument.
2. Connect the flexible tube to the top part of the device and then the filter to this tube.
3. Connect the flexible tubes to the Teflon tubes attached to the cap.
4. To turn on the instrument press and hold the MODE key.
5. When the display turns on, release the MODE key.





6. When the display shows "Ready ... Start sampling?" press the Y/+ key to start the measurement.
7. Zeroing calibration: Every day, before starting any measurement, a Zeroing calibration is recommended.
 - a. Go to a fresh air environment.
 - b. Press and hold the MODE and N/- keys at the same time.
 - c. A password will be required (normally "0000"). Use the Y/+ and N/- keys to change numbers. Press Enter (MODE key).
 - d. Select "Calibration" and "Zero calib".
 - e. When the display shows "Please apply zero gas..." press Y/+ key to start calibration and wait for 30 seconds, and the calibration is finished.
8. Span calibration: before each competition the MiniRAE Lite shall be calibrated with a span gas. For Olympic and Paralympic Games this calibration shall be done daily, after the Zeroing calibration. This operation shall only be done by an experienced person. A bottle of 10 ppm of Isobutylene shall be used as a reference gas for the span calibration.



FLATNESS TEST





5. FLATNESS TEST

5.1. ELECTRONIC FLATNESS DEVICE

This device consists of a gauge set in the center of a supporting body which spans the racket. The body is placed across the racket and the gauge's contact point will touch the rubber. The gauge displays the difference in height between the center and the edges.

For convex racket coverings (center thicker than edge), the gauge shows readings > 0.00 mm; for concave racket coverings (center thinner than edge) the gauge shows readings < 0.00 mm.



TEST PROCEDURE:

1. Turn on the gauge. Make sure it is set to display millimeters, not inches.
2. Rest the device on the flat calibration block and reset the gauge to 0.00 if necessary.
3. Place the device across the rubber, being sure that the device is not resting on the raised moulded branding area of the rubber. Read the gauge display.
4. Perform at least 2 diagonal measurements on each side of the racket; one as shown in the picture above, and another in the perpendicular orientation.
5. Record both flatness values for each side. Do not take an average. Both measured flatness values must be ≥ -0.50 mm and $\leq +0.20$ mm.

5.2. ELECTRONIC FLATNESS DEVICE WITH ADJUSTABLE FEET

This is an optional step which can be taken if the flatness device has adjustable feet.

TEST PROCEDURE:

1. Place a straightedge (such as a net gauge) along the racket surface to see if there are visible hills or valleys – localized areas which are distinctly not flat.
2. If there is such an area, adjust the feet of the device such that the contact point will touch the highest magnitude point, while the feet span the point.
3. Reset the gauge to 0.00 on the calibration block.
4. Place the device on the rubber to measure the area which was identified.
5. Record the reading if it exceeds the specified limits. Note that this localized flatness reading should not be added to a thickness reading.

In the example below, a cut-out area has been identified (left picture). The flatness device is adjusted to measure the hill by placing the left foot into the cutout. Alternately, the valley could be measured by shifting the device to the left, placing the gauge contact point in the valley.



5.3. MANUAL FLATNESS DEVICE – NET GAUGE

A striking surface must be flat. A net gauge laid down with its straight edge on the rubber and observed against the light should not show a gap between it and the rubber. In the call area, if an umpire is satisfied with the flatness there is no need to perform a measurement. When measured, the magnitude of curvature may not be more than 0.2 mm when the shape is convex, and 0.5 mm when the shape is concave.

The magnitude of curvature can be tested by using standardized steel blades. In the picture above, the net gauge rests on 0.2 mm blades. If the center of the net gauge touches the rubber surface, this indi-

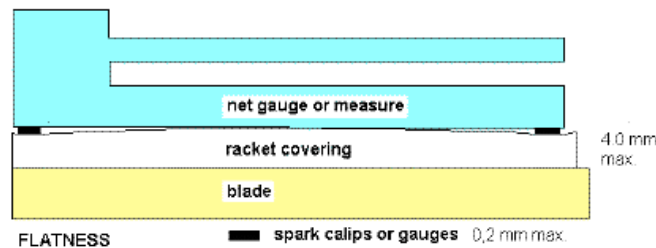

cates that this side of the racket is convex.

Optionally, tape that is 0.2 mm thick may be affixed to a net gauge for convenience, as shown below. The thickness of the tape can be verified using calipers or the electronic flatness measurement device. This permits a quick test for flatness using the method previously described.





5.4. PRINCIPLE AND RATIONALE

The flatness of a racket must be checked because of two reasons:

- a. Flatness by itself is a requirement of Law 2.4.1
- b. The thickness of the covering is measured at four points which are not in the center of the racket. There are several ways to use non-flatness in order to achieve an illegal thickness at other points of the covering. For example: Gluing a "bubble" in the center of a racket; having a "hill" in the direction of the handle etc.

For these reasons, a difference between the level of the edge points and the level of the center of the racket shall be detected and the result shall be used in two different ways:

- a. The result as it stands (worst of two values) will determine pass or fail for flatness.
- b. A concave covering has its maximum thickness at the edges. Therefore, this maximum is already covered by the thickness test itself. Nothing needs to be added or subtracted. A convex covering has its maximum thickness in the center. Therefore, the flatness result (= center minus edge) has to be added to the thickness result (= edge). A covering just appears convex because the bent is blade shall only be regarded convex to the extent not caused by the blade. This extent equals the difference of flatness on the convex side minus flatness on the concave side, and only this figure, if still positive, shall be added to the thickness result.

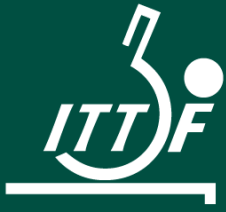

THICKNESS TEST





6. THICKNESS TEST

6.1. ELECTRONIC THICKNESS DEVICE

This device consists of a gauge set at the end of a supporting body. The body is placed on the rubber surface and the gauge's contact point touches the bare zone of the blade between the handle and the end of the rubbers as shown in the figure below.



TEST PROCEDURE

1. Turn on the gauge. Make sure it is set to display millimeters, not inches.
2. Rest the device on the flat calibration block and reset the gauge to 0.00 if necessary.
3. Place the device across the rubber such that the gauge's contact point rests on the blade, being sure that the device is not resting on the raised moulded branding area of the rubber.
4. For each side of the racket, perform and record 4 measurements in the orientations below.

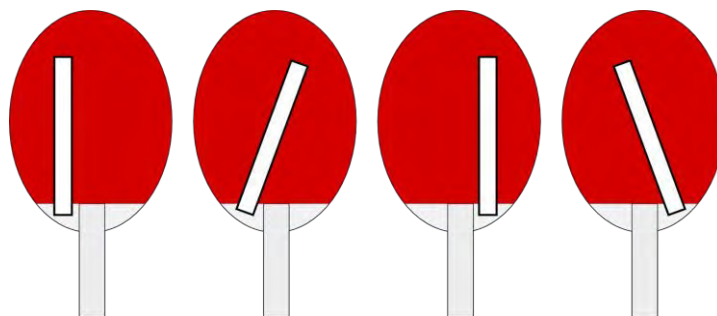

5. Calculate and record the average of the four readings.
6. When thickness will be measured the sign (+ or -) before the result shown on the device will change (i.e.: -3,95 → 3,95 or 0,05 → -0,05).
7. If this side (A) of the racket is convex (one or two positive measurements in the flatness test), the measured flatness may need to be added to the thickness. Perform one of the following:



- a. If this side (A) is convex and the reverse side (B) is flat (zero value) or convex (positive value), add the flatness measurement of this side (A) to the thickness measurement (Example 1).
 - b. If this side (A) is convex and the reverse side (B) is flat (zero value) or concave (one negative measurement in the flatness test),
 - i. and the sum of the two flatness measurements is positive, add this sum to the thickness measurement (Example 2).
 - ii. and the sum of the two flatness measurements is zero/negative, add nothing (Example 3).
8. If this side (A) of the racket is flat (zero value) or concave (negative measurements in the flatness test), the other sides flatness is not important and nothing will be added to the measured thickness (Example 4).

Example 1:

	Scenario 1	Scenario 2	Scenario 3	Scenario 4
Thickness measurement of coloured side (A)	3.90	3.90	3.90	3.90
1. Flatness of coloured side (A)	+0.10	+0.10	+0.10	+0.10
2. Flatness of coloured side (A)	+0.05	-0.05	0.00	-0.05
1. Flatness of black side (B)	+0.05	+0.05	+0.05	0.00
2. Flatness of black side (B)	0.00	0.00	+0.10	0.00
Final thickness result of coloured side (A)	4.00	4.00	4.00	4.00

In bold are the values that will be used for calculation.

Example 2:

	Scenario 5	Scenario 6	Scenario 7	Scenario 8
Thickness measurement of coloured side (A)	3.90	3.90	3.90	3.90
1. Flatness of coloured side (A)	+0.10	+0.10	+0.10	+0.10
2. Flatness of coloured side (A)	+0.05	-0.05	-0.05	-0.05
1. Flatness of black side (B)	+0.05	+0.05	0.00	-0.08
2. Flatness of black side (B)	-0.05	-0.05	-0.05	-0.05
Final thickness result of coloured side (A)	3.95	3.95	3.95	3.92

In bold are the values that will be used for calculation.

Example 3:

	Scenario 9	Scenario 10	Scenario 11	Scenario 12
Thickness measurement of coloured side (A)	3.90	3.90	3.90	3.90
1. Flatness of coloured side (A)	+0.10	+0.10	+0.10	+0.10
2. Flatness of coloured side (A)	+0.05	-0.05	+0.05	-0.05
1. Flatness of black side (B)	+0.05	-0.05	-0.05	+0.10
2. Flatness of black side (B)	-0.10	-0.10	-0.20	-0.20
Final thickness result of coloured side (A)	3.90	3.90	3.90	3.90

In bold are the values that will be used for calculation.



Example 4:

	Scenario 13	Scenario 14	Scenario 15	Scenario 16
Thickness measurement of coloured side (A)	3.90	3.90	3.90	3.90
1. Flatness of coloured side (A)	-0.10	-0.10	0.00	0.00
2. Flatness of coloured side (A)	0.00	-0.05	0.00	0.00
1. Flatness of black side (B)	-0.05	-0.05	+0.05	+0.05
2. Flatness of black side (B)	+0.05	-0.10	-0.10	+0.10
Final thickness result of coloured side (A)	3.90	3.90	3.90	3.90

CONCLUSION

The thickness limit is defined under the Laws of Table Tennis of the ITTF Statutes + a measurement tolerance of 0.05 mm, and the result of the electronic device is rounded to the number of digits specified in the Law.

For example, if the Law requires thickness to be less than 4.05 mm with sponge and less than 2.05 mm without sponge, then:

- For racket coverings with sponge, the limit would be <4.10 mm.
- For racket coverings without sponge, the limit would be <2.10 mm.

Recall that the limit is applied to the average of four readings which is rounded to two digits. As two examples, with the limits as above:

4.10 / 4.09 / 4.09 / 4.09, which is in average 4.0925 mm = 4.09 mm, passes the racket control.

Opposite, 4.10 / 4.10 / 4.09 / 4.09, which is in average 4.0950 mm = 4.10 mm, fails the racket control.

PRECAUTIONS

- If the wood near the handle is uneven, the gauge's contact point should carefully be placed in a spot which reflects the level of the blade.
Example 1: If a small piece of wood is missing, then the contact point must not be placed on this spot, or the reading will be too thick.
Example 2: If there is excess glue or lacquer on all spots but one, then the contact point must be placed on this spot, or the reading will be too low. If no such spots are available, ask the player to scratch off some lacquer. If the player refuses, refer the matter to the referee.
- If all the wood near the handle contains a layer of lacquer which does not cover the entire blade, and for any reason cannot be removed anywhere, then the estimated thickness of the lacquer must be added to the electronic thickness result. As a guide, such layers should not normally be thicker than 0.1 mm. A loupe can be used to measure the lacquer's thickness.

6.2. OPTICAL THICKNESS DEVICE – LOUPE

A magnifying glass (loupe) can be used when there is no possibility to check the thickness of a specific racket with an electronic device, regardless of whether such a device is actually available. It can also be used if there are doubts that the electronic device is measuring the real thickness of a rubber.

Some cases in which a loupe would be used are:



- An electronic device is not available.
- The wood near the handle has a layer of lacquer and the player refuses to remove it.
- The wood near the handle carries an additional layer of cork.
- The wood near the handle has a specific form which does not allow the contact point of the electronic device to rest on it at the same level as the blade.
- The rubber's moulded branding area (rubber name, ITTF number etc.) has an extension which does not allow the contact point to rest on the wood while the device rests on the flat rubber.
- In case of doubt that the electronic device can measure the actual thickness of the racket covering, due to any irregularity or unusual racket construction. In these cases, measurement by loupe should take precedence over the electronic device.

LOUPE TOLERANCES

When a loupe is used, the relative accuracy of the loupe may be evaluated by measuring a racket covering with the electronic thickness measurement device and comparing the result with the measurement taken with the loupe.

The referee may specify a tolerance to be applied when using a loupe. The tolerance of a loupe is dependent on its magnifying power and the scale of the reticle divisions; for a typical loupe, a tolerance of one-half scale unit or one scale unit can be expected, i.e. a loupe with a 0.1 mm scale may have a tolerance of 0.05 mm or 0.10 mm applied.

6.3. MANUAL THICKNESS DEVICE – NET GAUGE

An initial thickness measurement can be made with a net gauge. A typical net gauge can be rested on the surface of the rubber, with the 4 mm protrusion aligned with the edge. Visual inspection will show whether the rubber is thicker than the 4 mm guide. Use the 2 mm protrusion on the other side for rubber without sponge. Care should be taken not to press the net gauge into the rubber.

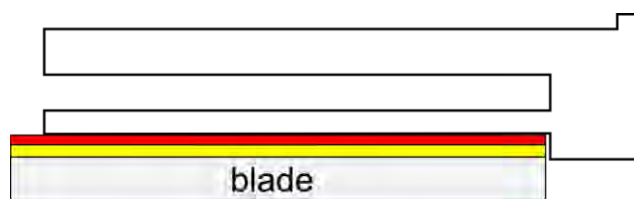

Alternately, the net gauge can be used in a manner similar to the electronic thickness device, with the net gauge in line with the handle. This method requires that the net gauge have a cutout with extra clearance to allow for the raised branding area on the rubber.

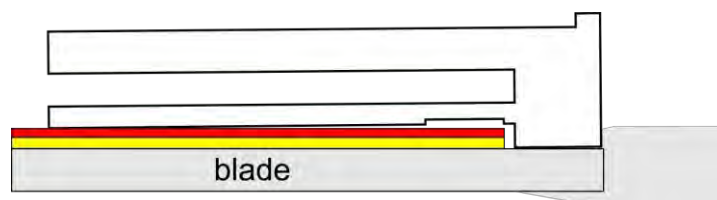



Rest the flat surface of the net gauge (left side in the pictures) on the rubber. If the 4 mm protrusion (right side) touches the blade as in the picture above, then the racket covering is less than 4 mm.

If the 4 mm protrusion does not touch the blade surface, as below, then the racket covering is thicker than 4 mm.

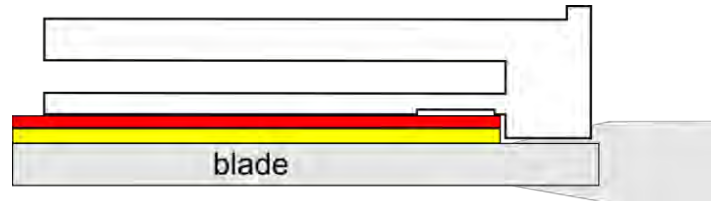

The 4 mm and 2 mm protrusions can be checked using the electronic thickness device. See the Laws of Table Tennis for the specified thickness limit.



6.4. PRINCIPLE AND RATIONALE

The thickness of the racket covering must be checked because it is a requirement of Law 2.4.3. An unlimited thickness will give advantages to those who can afford the most extreme industrial developments, so that the skill of a player may no longer be the main driver of a match result.

The thickness can normally be determined by evaluating the difference between the level of the covering and the level of the wood. However, there are cases where this measurement cannot be reliably performed. Then an optical measurement of the covering's thickness at the edge of the blade is in order.

It should be decided case by case which is the most accurate way to determine the thickness of a covering. However, in different tests of the same racket in the same tournament, consistency of the applied procedure should be ensured. A slight change of results in every test is normal, but a player who encounters erratic results, such as 3.92 in a first test and 4.09 in a second one, will lose confidence in the racket testing.

However, consistency should not be used as an argument for ignoring an unexpected result. It is quite possible that a racket with a thickness close to the limit will, for example, pass a test in the morning and will fail in the afternoon. Conditions of a racket may change slightly during the day, and this is the player's responsibility if he or she has chosen to use a racket at the limit. Preferably, this should be explained to a player already when the result is a "passed, but close". But definitely it shall be explained in cases of failure.

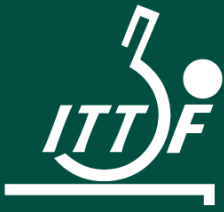

DISMANTLING RACKETS





7. DISMANTLING RACKETS

In certain circumstances, based on the respective rules, a post-match racket control test may include the dismantling of a racket, i.e., the rubber to be removed from the blade. The primary objective is to check whether there is an irregularity on the racket covering or blade, for example in a way which could have affected the measurements of thickness as described in section 6.

7.1. PROCEDURE

Dismantling of rackets is not part of the umpires' after-match duties and should be performed by trained racket testing staff and in the racket control room, only. The referee will be called to the racket control room, **double check the findings of the racket tester** and decide based on **the these** measurement results **by the racket tester** whether dismantling is required or not.

Reasons for deciding that the racket be dismantled after the match include (but are not limited to):

- The racket is submitted to the racket control room before the match or after the match (due to delay of the player before the match):
 - and the result of the thickness measurement is an acceptable figure but does not look reasonable to the racket tester - for example because a check with a net gauge or a loupe suggests a bigger thickness.
 - and the result is more than 4.05 mm, so that the racket tester has to double check this value with the dismantling procedure.
 - and any preparation on the visible blade parts, e.g.: certain amount of lacquer on the handle area has been inspected which could lead to an after treatment on the blade.
- **With the rubber surface of the racket, it looks like the pimples come to the surface and the rubber edge bends outwards.**
- **The appearance of the blade is leaving doubts about its carving to the umpire who checks the racket in the Call Area but cannot be proven legal/illegal unless examined separately.**

In case a post-match dismantling is decided, the umpires of the match are informed as early as possible, preferably before they appear at the playing area and start the match preparation. The referee shall inform the player before the match that the racket will be collected for dismantling after the match. Should, for any reason, the racket be replaced before or during the match, both the original racket and its replacement will be collected and dismantled after the match.

After the match, the umpires shall collect the racket(s) and submit it/them immediately to the racket control room, so that the racket can be checked and dismantled if there is a doubt. There is no need to also collect the opponent's or doubles partner's racket, unless it was individually decided that this racket be also dismantled. The following individuals are admitted to the racket control room for the dismantling procedure: The player, one representative of the player's association, the referee, and ITTF racket testing staff (not limited but kept at a minimum). Apart from these people, the racket tester shall keep any result strictly confidential.

If the player is present, he/she shall be invited by the racket tester to dismantle the racket. If the player refuses or is not present, the player will bear the consequences that are pronounced by the referee. The racket covering(s) should be then examined according to section 7.2. while the blade is then examined according to section 7.3.

If ok, the racket will be given back to the player. If that is not ok, the referee can decide about further consequences.

The racket tester shall only make decisions of fact about the racket covering(s) and blade. Judicial comments, such as whether a player has committed a deliberate infraction or not, are the competency of the referee and should be strictly avoided by a racket tester.

The dismantling procedure may or may not include further measurements at the discretion of ITTF, the referee or the racket tester. Whereas the detection of an illegal blade may have consequences, regardless of whether this was the source for the different thickness readings.

This procedure may be adjusted by the referee to what is practical in the event, for example by appointing additional officials for any of the tasks described above.

7.2. RACKET COVERING CHECKS

The main objective of the racket covering check is to detect irregularities which may give the player an unfair advantage. The most common of such advantages is the ability to use a rubber which exceeds the thickness limit of Law 2.4.3.

To understand how this can happen, the racket tester should use a thickness device as for example KÄFER J200/JD200 device to measure 4 different points on positions with normal adhesive layers. The average value should not overpass the limit of Law 2.4.3.

Test procedure:

1. Check that the gauge value is 0.00 mm.
2. Check that there are no particles between the measuring plate and measuring pin.
3. Use the 4,00 mm calibration block; the result should be ~4,00 mm.
4. Insert the racket covering between measuring plate and pin, take care not to measure on adhesive knots.
5. Measure 4 points and calculate the average with 2 digits.

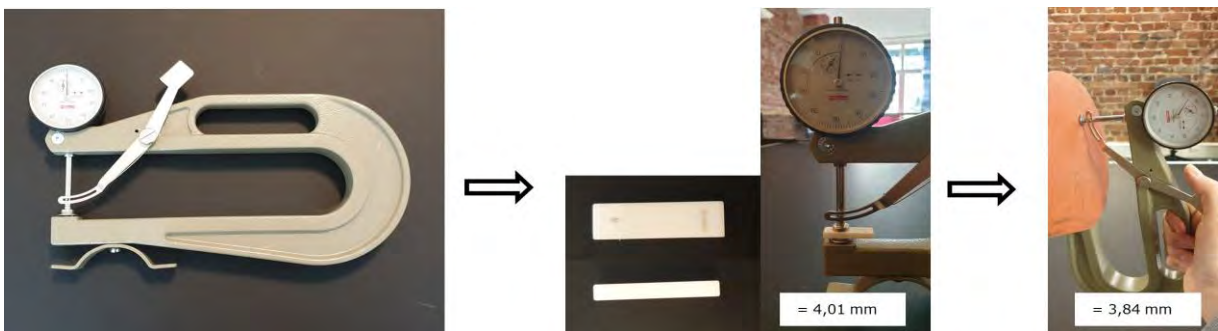

The thickness limit is defined by Law 2.4.3 + a measurement tolerance of 0.05 mm, and the result of the electronic device is rounded to the number of digits specified in the Law.

For example, if the Law requires thickness to be less than 4.05 mm with sponge and less than 2.05 mm without sponge, then:

- For racket coverings with sponge, the limit would be <4.10 mm.
- For racket coverings without sponge, the limit would be <2.10 mm.

Recall that the limit is applied to the average of four readings which is rounded to two digits. As two examples, with the limits as above:

4.10 / 4.09 / 4.09 / 4.09, which is in average 4.0925 mm = 4,09 mm, passes the racket control.

Opposite, 4.10 / 4.10 / 4.09 / 4.09, which is in average 4.0950 mm = 4,10 mm, fails the racket control.



With the dismantling also the glue layer should stick to the racket covering.

- In case there is no glue layer at the measuring points on the dismantled racket covering, another racket covering part with glue layer should be measured.
- If there is no glue layer on the racket covering at all and all glue is stuck to the blade, the following procedure will take place: the blade without racket coverings but with the glue layer on it will be measured with the thickness device (in average of all 4 spots, i.e.: 0,20 mm). Afterwards the glue will be removed from the blade, and the testing will be done as the blade flatness testing with the thickness device (in average of all 4 spots, i.e.: -0,05 mm). The calculation of the two results will be the glue layer thickness (i.e.: $0,20 + -0,05 = 0,15$ mm), that should be added to the dismantled racket covering results measured with the off-blade thickness device (Spot 1: $3,80 + 0,15 = 3,95$ mm; Spot 2: $3,77 + 0,15 = 3,92$ mm, etc.).

7.2.1. RESHAPING

The thickness data checked in the off-blade measurement may lead to different data from normal racket control on-blade. Such differences should be considered as normal reshaping of the racket covering due to its physical properties after being dismantled from the blade. But such reshaping should still stay in the limit of Law 2.4.3

Racket Control Value	Dismantling Value	Remarks	Result
3.98	4.04	with sponge	PASS
3.98	4.12	with sponge	FAILURE
1.98	2.04	without sponge	PASS
1.98	2.12	without sponge	FAILURE

The tolerance of 0.05mm on top of the limit specified in Law 2.4.3 is intended to also cover any reshaping, for the benefit of the players. In return, players are strongly advised not to exploit the full tolerance when gluing the rubber to the blade. It is the player's responsibility that the rubber complies with the above limits both on and off the blade.

7.2.2. COMPENSATION

If a racket has been dismantled, the player can ask for compensation of the dismantled racket coverings.



7.3. BLADE CHECKS

The main objective of the blade check is to detect irregularities which may give the player an unfair advantage. The most common of such advantages is the ability to use a rubber which exceeds the thickness limit of Law 2.4.3. To understand how this can happen, the racket tester should recall that the thickness device does not measure the mere *thickness* of the rubber but the *height difference* between the rubber and the blade near the handle: The device has a metal “pin” (here between the tester’s fingers) and two plastic “feet” (resting on the rubber). The thickness result equals the extent to which the pin goes below the level of the plain created by the feet.

Here are the basic examples of what may make either the rubber thickness or a blade itself illegal. The Term of Reference which is backing this is Law 2.4.5: “*The blade, any layer within the blade and any layer of covering material or adhesive on a side used for striking the ball shall be continuous and of even thickness.*”



7.3.1. LACQUER NEAR THE HANDLE

In this picture the lacquer sheet near the handle appears to be thicker. Especially when the “end” of the rubber near the handle coincides with the “beginning” of the lacquer, this will create a problem: The pin of the thickness device will rest on the lacquered part of the blade, so that the height difference between the pin and the feet resting on the rubber is reduced.

Example: Say the lacquer has a thickness of 0.3 mm and the rubber is in fact 4.3 mm thick, which is illegal. Then the thickness device will record a thickness of only $4.3 - 0.3 = 4.0$ mm, which would be



legal.

(Although it is generally legal to cover the area near the handle with arbitrary material, in this case an illegal thickness is created which can be detected only after dismantling. Therefore, this outcome is considered a failure in the combination of blade and rubber which may overrule a pre-match thickness test.)

7.3.2. SANDED BLADE (STRIKING PART OF HANDLE)

Instead of *increasing* blade thickness near the handle, the opposite would have the same effect: *Decreasing* the blade thickness everywhere else but near the handle. This happens when the blade is sanded.



In this picture, the sanding may be concluded from two observations:

- 1) The branding inscription is almost gone
- 2) There are significant variations in the colour of the wood (note for example the area between the two green lines)



Moving the fingers over the blade, switching between the area near the handle and the rest of the blade, may indicate a height difference and / or a difference in roughness. A substantial concavity fails the racket - whether or not the rubber is too thick. Concavity can be visualized or measured by using one of the methods used for checking the flatness of a rubber - for example by using a net gauge resting over the area and showing a gap in the middle, or by using the electronic flatness or thickness device to measure a height difference.

7.3.3. SANDED BLADE (AREA NEAR HANDLE ONLY)

Even when only a small part of the blade is sanded, this will affect the measurement with the thickness device. In this picture, only the area between the two green lines is sanded. In this area, with the rubber on it, the proximal foot of the thickness device comes to rest, i.e. the foot which is closer to the pin. This foot is then resting lower than the distal foot, i.e. the one far from the pin. This creates a falling level towards the device's pin - and this causes the pin to measure less height.



Therefore, a substantial concavity, to be detected like in the previous example, fails the racket, whether or not the rubber is too thick.

7.3.4. BLADE MEASUREMENTS







Consequently, the racket tester should first perform a standard thickness measurement with the rubber on the racket (see section 4.1) and then, after dismantling, measure the thickness of for all doubtful cases (lacquer on the handle, sanded blade at striking part and sanded blade at handle near) with the electronic thickness device (similar spots as in 4.1 only on the pure blade). The allowed limit of height difference between handle and striking/playing area should be between -0.50 mm and +0.20 mm at any checking spot. Afterwards the dismantled racket covering will be measured as described in 7.2.



7.4. CONCLUSION







Further explanations are described in the following graphics:

RACKET CONTROL TEST PROCEDURE – ON vs. OFF THE BLADE (Racket Covering without glue + two blade sides)

1. Blade Side A – not manipulated	2. Racket Covering – Thickness with Käfer J200 [mm]	3. Racket Control before the match [mm]	4. Flatness with the thickness device [mm]	5. Racket Covering – Dismantling [mm]
				
		-3,79	-0,04	
		PASS Racket Control	PASS Blade Check	
		-3,35	FAIL Blade Check	
				
			+0,38	PASS Racket Covering Check
1. Blade Side B – manipulated/sanded	2. Racket Covering – Thickness with Käfer J200 [mm]	3. Racket Control before the match [mm]	4. Flatness with the thickness device [mm]	5. Racket Covering – Dismantling [mm]

Slight differences between the measurement with Racket Control on Blade device and Racket Control off Blade device are normal (see abstract of reshaping).
A minus value (-3,80mm) with the DHS device means that the playing area is 3,80mm thicker as the handle area. A plus value (+0,38mm) means the playing area is thinner as the handle area.

RACKET CONTROL TEST PROCEDURE – ON vs. OFF THE BLADE (Racket Covering without glue + two blade sides)

1. Blade Side A – not manipulated	2. Racket Covering – Thickness with Käfer J200 [mm]	3. Racket Control before the match [mm]	4. Flatness with the thickness device [mm]	5. Racket Covering – Dismantling [mm]
				
		-3,79	-0,04	
		PASS Racket Control	PASS Blade Check	
		-3,35	FAIL Blade Check	
				
			+0,38	PASS Racket Covering Check
1. Blade Side B – manipulated/sanded	2. Racket Covering – Thickness with Käfer J200 [mm]	3. Racket Control before the match [mm]	4. Flatness with the thickness device [mm]	5. Racket Covering – Dismantling [mm]

Slight differences between the measurement with Racket Control on Blade device and Racket Control off Blade device are normal (see abstract of reshaping).
A minus value (-3,80mm) with the DHS device means that the playing area is 3,80mm thicker as the handle area. A plus value (+0,38mm) means the playing area is thinner as the handle area.



ADDITIONAL NOTES

When flatness is measured (with on-blade flatness device or on-blade thickness device), the result shown on the device will stay (i.e.: 0,20 → 0,20 or -0,15 → -0,15).

When thickness is measured (with on-blade thickness device), the sign (+ or -) before the result shown on the device will change (i.e.: -3,95 → 3,95 or 0,05 → -0,05).

Slight differences between the measurement with racket control on blade device and racket control off blade device are normal (due to device tolerances and reshaping).

A minus value (-3,80 mm) with the on-blade thickness device means that the playing area is 3,80 mm thicker than the handle area. A plus value (+0,38 mm) means the playing area is thinner than the handle area.

An irregular blade may appear in different facets and extents, most of which can be detected by looking at the colour of the wood, feeling its roughness or measuring a height gap. Any of these irregularities, if significant, may influence the rubber thickness test and therefore should be taken seriously. The dismantling racket tester should bring any doubtful case before the referee, however avoiding any prejudice about responsibilities and consequences.

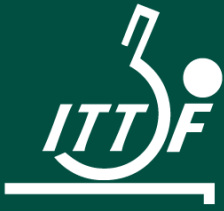

OPTIONAL TEST





8. OPTIONAL TEST

The following tests are strictly optional and, in general, should only be used in cases of doubt which was found by inspection. They should not be a part of the normal racket testing procedure.

8.1. PIMPLE DENSITY

The pimple density of racket coverings is measured during the ITTF authorisation process, and therefore measurement of pimple density normally is not needed during racket control. However, in some cases the density is modified by the user, by stretching or other means. If there is doubt that the pimple density is within the specified limits, it can be quickly verified using a loupe.

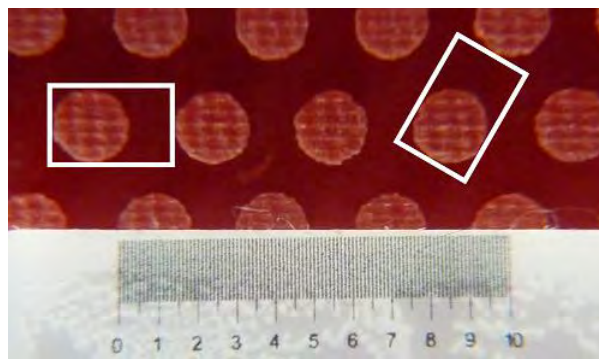

Measure the pimple spacing, defined as the diameter of an individual pimple plus the space to a neighboring pimple, shown with the white boxes above. (In this example the pimple spacing is approximately 3.0 mm.)

The measured pimple spacing must be < 3.5 mm. A spacing of 3.5 mm or more indicates a pimple density below the minimum limit.

8.2. COLOUR

The colour of racket coverings is measured during the ITTF authorisation process; however, due to variations in production, it is possible that particular batches of rubber will not meet the precise requirements of Manual M4.

At this time, ITTF recommends use of the following guidelines:

- If the colour of the rubber is uneven, for example part of the hitting surface is faded – the racket shall be submitted to the referee.
- If a coloured pimples-out rubber is used with no sponge, and dark wood shows through it causing the overall appearance to be dark, or lettering printed on the blade shows through it causing it to be uneven – the racket shall be submitted to the referee.
- In all other cases, if the coloured rubber does not appear “bright colour” but meets all other requirements – it is recommended that use of the racket be permitted, as long as the opponent can clearly and easily distinguish the coloured side from the black side.

If a racket covering does not appear in bright colour, and it is believed to be caused by a production fault from the rubber manufacturer, please send a message and photo to the ITTF Equipment Department for further investigation.



8.3. GLOSS

Gloss of racket coverings is measured during the ITTF authorisation process; however, the gloss of a particular sheet of rubber may exceed the specified limit due to variations in production, or due to use.

At this time, the ITTF recommends that judgment of gloss be based on whether the gloss would adversely affect an opponent. Gloss measurement in racket control is not recommended.

If a racket covering seems excessively glossy, and it is believed to be caused by a production fault from the rubber manufacturer, please send a message and photo to the ITTF Equipment Department for further investigation.



SANCTIONS





9. SANCTIONS

9.1. VOLUNTARY TEST

Please refer to the article 3.2.4.2.4 of the ITTF statutes.

9.2. Voluntary test PRE-MATCH RACKET CONTROL TEST

Please refer to the article 3.2.4.2.3 of the ITTF statutes.

9.3. Voluntary test POST-MATCH RACKET CONTROL TEST

If a player fails in any racket control test after the match has been completed:

- on the blade (in case no on the blade measurement in the before match control has been done), or
- in the off blade/dismantling control,

the player's name will be written down on the infraction list and the referee will decide, taking into consideration any recommendation by the racket tester, if any additional sanction will be handed against that player. Without limiting the penalties stated under the ITTF Statutes, one or more of the following sanctions may be handed to the player in addition to recording their name down in the infraction list:

- a censure, reprimand, or warning,
- a fine of up to CHF10.000,
- a disqualification of results and outcomes of results in the relevant ITTF Sanctioned Events, including a forfeiture of any related awards, titles, ranking points or prizes; and
- a suspension from competing in any ITTF Sanctioned Events for up to 12 months.

If a player fails the racket control test with the first racket in the pre-match control test and subsequently, fails the post-match racket control test with their 2nd racket in the off blade or on the blade measurement, the player will get two notices on the infraction list at the same event.

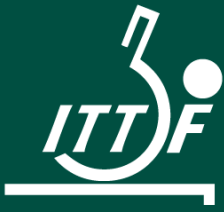

APPENDIX - SUMMARY OF RACKET TESTS





10. APPENDIX – SUMMARY OF RACKET TESTS

#	Test	Specification	Remark / Example	Perform this test at:		
				Match Table	Call Area	Racket Control
2	Regularity of Blade and Racket Coverings	Tolerance from referee	Extension of rubber, scratches, missing pimples, broken wood, etc.	Yes	Yes	Yes
3	Authorisation of Racket Coverings	Must be on LARC	brand name, product name, ITTF logo and code/number	No	Yes	Yes
4	Volatile Organic Compounds	VOC level \leq 3.3 ppm	Differential reading after 20 seconds.	No	No	Yes
5	Flatness	Concave \geq -0.50 mm Convex \leq +0.20 mm	Worst of 2 perpendicular measurements. Do not average.	No	Yes	Yes
6	Racket Covering Thickness	With sponge: < 4.05 mm Without sponge: < 2.05 mm (plus a measurement tolerance of 0.05 mm)	Average of 4 measurements; 2 parallel, 2 across.	No	Yes	Yes
7	Dismantling	Blade of even thickness; \geq -0.50 mm to \leq +0.20 mm	No overthick lacquer, no sanding	No	No	Yes
		see 6 - Racket covering thickness	Average of 4 measurements	No	No	Yes
8	Pimple Spacing	Width of pimple + space < 3.5mm		No	No	Optional

End of M9



ITTF WORLD CUP

PLAYING & QUALIFICATION SYSTEM

ITTF Mixed Team World Cup
Chengdu 2026

ITTF.com



COMPETITION DETAILS

1. NUMBER OF PARTICIPANTS AND INVITATIONS:

Teams

- 20 teams comprising a minimum of three and maximum of four players per gender.
- Each team shall be accompanied by a non-playing coach.

Invitations

- The 5 winners of the continental qualification events will qualify. One team per continent. If no continental event was held the highest ranked team of the continent based on the Qualification and Seeding list of 17 August 2026
- Minimum of fourteen (14) and Maximum of fifteen (15) teams invite on based on the Qualification and Seeding list of 17 August 2026 (see Note 1)
- Host team one (1) if not already qualified.

2. NUMBER OF DAYS

- 8 competition days

3. PLAYING SYSTEM

- There will be a total of 106 matches (90 in the group stage + 16 position matches)
- In the group Stage, the teams will be divided into 2 equal groups of 10 teams each one, with all the members of a group playing each other (round robin).
- In the group stage, the highest-ranked team will be placed in Group 1, the 2nd highest in Group 2, the remaining teams will be drawn into the groups 2 at a time in seeding order (modified snake system).
- The Teams finishing Top 8 of each group will play for their respective positions
- Positions will be played as follows:
 - Group 1st and 2nd -> Semi-finals and Finals, position 3 will be played
 - Group 3rd and 4th -> positions 5 to 8
 - Group 5th and 6th -> positions 9 to 12
 - Group 7th and 8th -> positions 13 to 16
- The tournament will be played in accordance with the Laws of Table Tennis and the Regulations for International Competitions with the exceptions described in Note 2.
- All team matches shall be played with the Mixed Team World Cup playing system as described in Note 2.
- The latest available ITTF Mixed Team World Ranking will be used for seeding. (see Note 1)



4. REALLOCATION

- If the winner of the Continental Qualification event is not available or withdraws, quota will be allocated to the runner up of the Continental Qualification event. If the Continental team spot was allocated by the Mixed Team WR, the spot will go to the second highest ranked team of the continent
- If any team invited by Qualification and Seeding list is not available or withdraws, the quota will be reallocated the next team in line according to the Qualification and Seeding list 17 August 2026.
- If the host team is not available or has already qualified, the quota will be reallocated the next team in line according to the Qualification and Seeding list 17 August 2026 without any restriction.
- Substitutions in or after 20 September, ITTF will invite the next team in line according to the Qualification and Seeding list 17 August 2026 without any restriction.

Note 1

Qualification and seeding lists shall be determined based on the Mixed Team Ranking.

* The ITTF Mixed Team World Ranking regulations are currently under discussion in the ITTF World Ranking Working Group. They will be published as soon as approved by the ITTF Executive Board



Note 2

PLAYING SYSTEM

- A team shall consist of minimum 3 and maximum 4 players per gender.
Team A: AM1, AM2, AM3, [AM4], AF1, AF2, AF3, [AF4]
Team X: XM1, XM2, XM3, [XM4], XF1, XF2, XF3, [XF4]
where M and F stand for Male and Female players
- A Toss when filling out the Team Composition at the call area shall decide the order of play. The winner of the toss can choose Women's first or Men's first.
- The order of play shall be:
Male option in toss
AM1 / AF1 vs XM1 / XF1
AM2 vs XM2
AF2 vs XF2
AM3 or AM4 / AM1 or AM2 or AM3 or AM4 vs XM3 or XM4 / XM1 or XM2 or XM3 or XM4
AF3 or AF4 / AF1 or AF2 or AF3 or AF4 vs XF3 or XF4 / XF1 or XF2 or XF3 or XF4
Female option in toss
AM1 / AF1 vs XM1 / XF1
AF2 vs XF2
AM2 vs XM2
AF3 or AF4 / AF1 or AF2 or AF3 or AF4 vs XF3 or XF4 / XF1 or XF2 or XF3 or XF4
AM3 or AM4 / AM1 or AM2 or AM3 or AM4 vs XM3 or XM4 / XM1 or XM2 or XM3 or XM4
Note: Each Team needs to align a minimum of 3 players per gender
- Team matches shall be played to a result where the first team to accumulate 8 games wins.
- All individual matches of a team match shall be played to 3 games (result 3-0 or 2-1), unless there is already a winner team in which case the match shall be finished with one or two games played
- Final ranking will be determined in terms of Regulation 3.7.5 (Note 3)
- Time-out rule as per regulation 3.4.4.2. Each player/pair is entitled to 1 time-out in each individual match.
- Misbehaviour which warrants yellow or yellow/red cards is covered in 3.5.2. Cards are carried forward in individual matches in each team match (3.5.2.3/3.5.2.6) but nothing is carried forward after the team match finishes.
- In the third game of a match the players or pairs shall change ends when one player or pair scores 5 points and in the third game of a doubles match the pair due to receive next shall change their order of receiving when one pair scores 5 points
- An equal number of male and female players must be registered on the match score sheet for each team match.
- A maximum of 4 players per gender, a team captain and an assistant will be allowed on the bench = 10 total!
- Each player is allowed to play in a maximum of 2 individual matches (doubles and singles) per team match.



Note 3

REGULATIONS

- 3.7.5 Group Competitions

- 3.7.5.1

In a group, or "round robin", competition, all members of the group shall compete against each other and shall gain 2 match points for a win, 1 for a loss in a played match and 0 for a loss in an unplayed or unfinished match; the ranking order shall be determined primarily by the number of match points gained. If a player is defaulted after the completion of a match for any reason, he or she shall be deemed to have lost the match, which shall subsequently be recorded as a loss in an unplayed match.

- 3.7.5.2

If two or more members of the group have gained the same number of matches points their relative positions shall be determined only by the results of the matches between them, by considering successively the numbers of match points, the ratios of wins to losses first in games and points, as far as is necessary to resolve the order.

- 3.7.5.3

If at any step in the calculations the positions of one or more members of the group have been determined while the others are still equal, the results of matches in which those members took part shall be excluded from any further calculations needed to resolve the equalities in accordance with the procedure of 3.7.5.1 and 3.7.5.2.

- 3.7.5.4

If it is not possible to resolve equalities by means of the procedure specified in 3.7.5.1-3 the relative positions shall be decided by lot.

- 3.7.5.5

Unless otherwise authorised by the Jury, if 1 team is to qualify to the next stage, the final match in the group shall be between the teams numbered 1 and 2, if 2 teams are to qualify to next stage, the final match shall be between the teams numbered 2 and 3.

QUALIFICATION SYSTEM

ITTF DOUBLES WORLD CUP



ITTF WORLD CUP



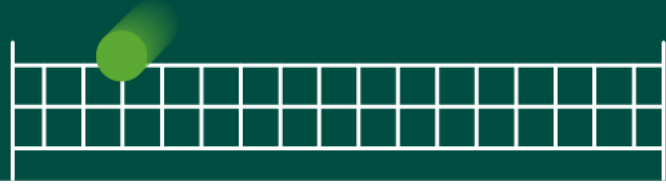

1. PARTICIPATION

- 1.1. The Doubles World Cup will host the following events: Mixed Doubles, Women's Doubles, and Men's Doubles.
- 1.2. Only Pairs with players from the same Member Association or National Olympic Committee will be accepted!
- 1.3. If a player has earned his or her participation in two or more pairs within the same event, he or she must select one (1) pair with which they will participate, within the timeline provided by ITTF at the time of the qualification notice.
- 1.4. A player qualified in two (2) or more pairs who has already accepted one entry will not have the right to change partner for any reason, even if the player is also pair of another eligible qualified pair.
- 1.5. There shall be Sixteen (16) pairs qualified in each of the different events for the World Cup.
- 1.6. There shall not be more than two (2) pairs from an association.

2. QUALIFICATION SYSTEM

- 2.1. Each continent shall be granted the opportunity to qualify one pair through a Continental Qualification Event (Continental Championships, Continental Cup or Continental Games). The winners of Africa, Americas, Asia, Europe and Oceania Continental Qualification Event, for a total of five (5) pairs.
- 2.2. Ten (10) additional pairs shall qualify through the World Ranking.
- 2.3. If no pairs qualify from the host association through items 2.1 or 2.2, then one (1) host association pair shall receive a nomination.
- 2.4. If a host association pair is already qualified through items 2.1 or 2.2 above, then one additional pair shall be added based on World Ranking.
- 2.5. The latest available WR on the date of publication of the initial invitations shall be used for selecting the qualified pairs ([Week]-[Day] [Month] [Year])

3. SUBSTITUTIONS

- 3.1. Substitutions before the entry closing date shall be as per entry regulations.
- 3.2. If the host association pair is not available or withdraws, they shall be replaced by another host association pair nominated by the host association.
- 3.3. If a Continental qualifier is not available or withdraws, the pair shall be replaced by the highest not yet Qualified ranked pair through the World Ranking of the initial invitation week players ([Week]-[Day] [Month] [Year])

4. ELIGIBILITY

Nominated players must be eligible to represent their Member Associations according to Regulation 4.3.6 in the ITTF Statutes.

PLAYING SYSTEM

ITTF DOUBLES WORLD CUP



ITTF WORLD CUP



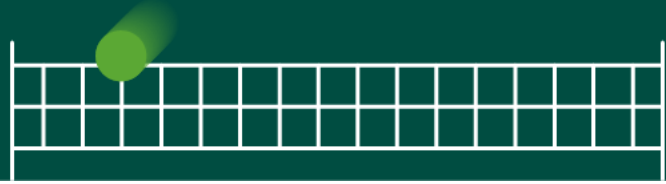

1. DOUBLES WORLD CUP PLAYING SYSTEM

- 1.1. Seeding shall be done according to the latest available Doubles Pairs World Ranking (**Week X - Day & Month 2027**)
- 1.2. The tournament shall consist of 2 stages.
- 1.3. In Stage 1 the players will be divided into 4 groups of 4 pairs, with all members of a group playing each other (round robin). Matches of Stage 1 shall be best of five (5) games.
- 1.4. For Stage 1, the highest-ranked pair will be placed in Group 1, the 2nd highest in Group 2, the 3rd highest in Group 3 and the 4th highest in Group 4; the remaining pairs will be drawn into the other groups using a modified snake system 4 at a time in ranking order.
The order of play in group matches will be:
round one 1 vs 3 & 2 vs 4
round two 1 vs 2 & 3 vs 4
round three 1 vs 4 & 2 vs 3
- 1.5. Pairs from the same Association will be drawn into separate groups.
- 1.6. The highest two ranked of each group shall qualify for the Stage 2 of the competition.
- 1.7. Stage 2 of the competition shall consist of a knockout draw. Matches of Stage 2 shall be the best of seven (7) games.
- 1.8. The draw for pairs will be as follows:
 - First-place finisher of Group 1 will be placed in position 1;
 - First-place finisher of Group 2 will be placed in position 8;
 - First-place finishers of Groups 3 and 4 will be drawn into positions 4 and 5.
 - Second-place finishers of the Groups will be drawn on the opposite site of the first pair from their group
 - Pairs finishing in third position in Groups will play a knockout draw to determine positions 9th to 12th.
- 1.9. There shall be no separation by Association in Stage 2.
- 1.10. Final ranking will be determined in terms of Regulation 3.7.5,
- 1.11. The World Cup will be played in accordance with the Laws of Table Tennis and the Regulations for International Competition.